



AFTERMARKET

**PERFORMANCE**



**DANA and SPICER® PRODUCTS  
for the JEEP® WRANGLER JK and JL**

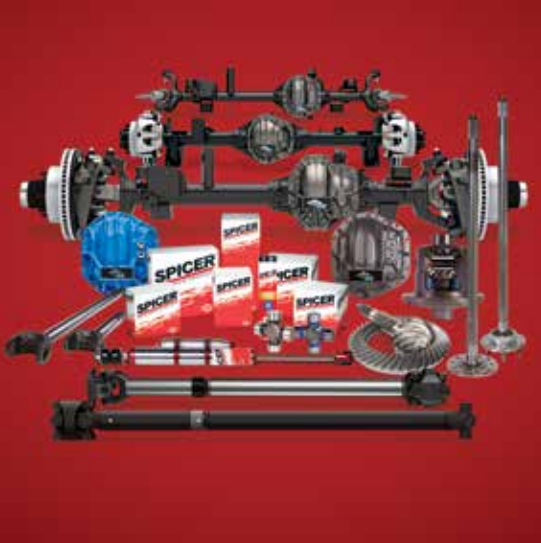

### JEEP® WRANGLER JL AXLE IDENTIFIER

| Trim         | Engine                 | Front Diff | Rear Diff     | Front Axle         | Rear Axle          |
|--------------|------------------------|------------|---------------|--------------------|--------------------|
| Sport/Sahara | 3.6L V6 and 2.0L Turbo | Open       | Open          | Dana 30™           | Dana 35™ AdvanTEK® |
| Sport/Sahara | 3.6L V6 and 2.0L Turbo | Open       | Trac-Lok™ LSD | Dana 30™           | Dana 44™ AdvanTEK® |
| Sport/Sahara | 3.0L Diesel            | Open       | Trac-Lok™ LSD | Dana 44™ AdvanTEK® | Dana 44™ AdvanTEK® |
| Rubicon      | 3.6L V6/ 3.0L Diesel   | ELD        | ELD           | Dana 44™ AdvanTEK® | Dana 44™ AdvanTEK® |

### JEEP® WRANGLER JK AXLE IDENTIFIER

| Trim         | Engine | Front Diff | Rear Diff     | Front Axle | Rear Axle |
|--------------|--------|------------|---------------|------------|-----------|
| Sport/Sahara | 3.6L   | Open       | Open          | Dana 30™   | Dana 44™  |
| Sport/Sahara | 3.6L   | Open       | Trac-Lok™ LSD | Dana 30™   | Dana 44™  |
| Rubicon      | 3.6L   | ELD        | ELD           | Dana 44™   | Dana 44™  |

**TRUSTED  
PRODUCTS FOR  
JEEP®  
FOR MORE THAN  
75 YEARS**



## TABLE of CONTENTS

- The Ultimate Dana 60™ Axles for the JL ..... 4-5
- The Ultimate Dana 44™ AdvanTEK® Axles for the JL ..... 6-7
- The Ultimate Dana 60™ Axles for the JK ..... 8-9
- The Ultimate Dana 44™ Axles for the JK ..... 10-11
- Spicer® Driveshafts for the Jeep® Wrangler JK and JL ..... 12
- Spicer® Nickel Chromoly Axle Shafts for the JK and JL ..... 15
- Spicer® Ring & Pinion Gearing for the JK ..... 16
- Spicer® AdvanTEK® Ring & Pinion Gearing for the JL ..... 19
- Spicer® U-Joints for the JK ..... 20
- Spicer® Ultra-Premium Synthetic Grease ..... 20
- Spicer® Performance Adjustable Shocks for the JK ..... 22
- Spicer® Inner Gear Kits for the JK and JL ..... 23
- Dana 60™ 35 Spline Drive Flange Kit for the JK and JL ..... 23
- Spicer® Performance Differential Covers for the JK and JL ..... 24
- Spicer® Performance Differential Gaskets for the JK ..... 25
- Spicer® Differential Carrier Cases for the JK and JL ..... 25
- Spicer® Front and Rear Axle Shafts for the JK and JL ..... 26
- Spicer® E-Locker Solenoid for the JK ..... 27
- Spicer® Bearing Kits for the JK and JL ..... 27
- Spicer® AdvanTEK® Ring & Pinion Upgrade Bundles ..... 28
- Spicer® Dana 44™ AdvanTEK® Ring & Pinion Upgrade Bundles ... 28-30
- Spicer® and SVL® Ring & Pinion Upgrade Bundles - Non-Rubicon JK .... 31
- Spicer® and SVL® Ring & Pinion Upgrade Bundles - Rubicon JK... 32-33
- The Ultimate Dana 44™ Axle Upgrade Packages - Rubicon JK ..... 34
- The Ultimate Dana 44™ Axle Upgrade Packages - Non-Rubicon JK..... 35
- Misc. Spicer® Axle Components for the JL ..... 36
- Misc. Spicer® Axle Components for the JK ..... 37
- The Dana-Jeep Story ..... 38

THE **ULTIMATE**  
**DANA 60™**  
 AXLES FOR THE **JEEP® WRANGLER® JL**

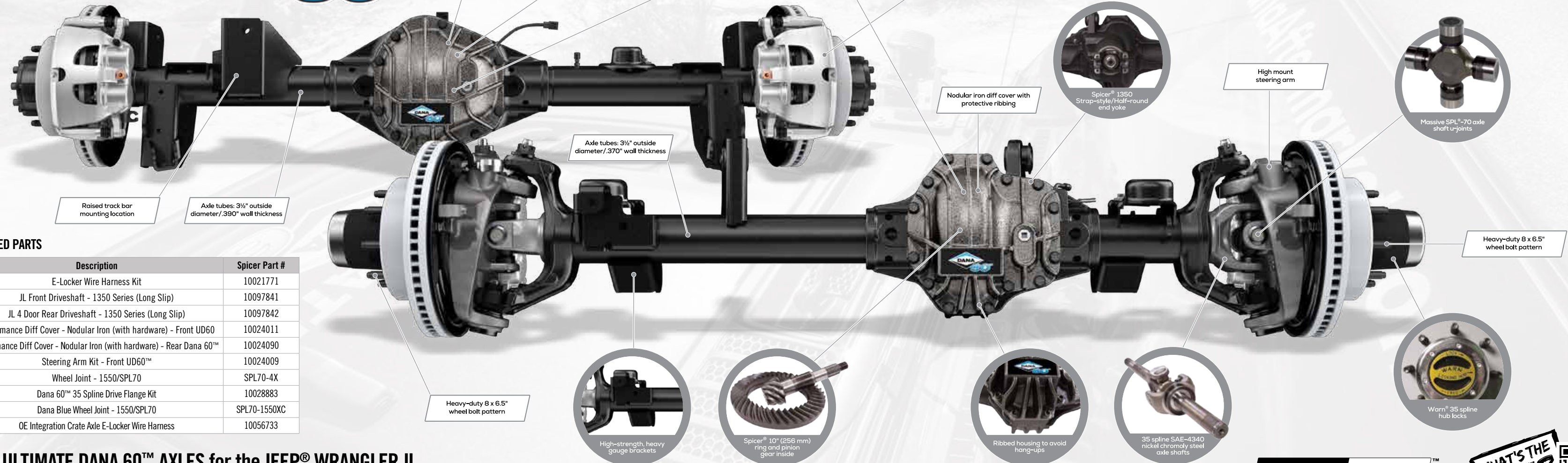

**THE ULTIMATE DANA 60™ CRATE AXLES (BOLT IN AXLE ASSY. FOR JL)**

| Application   | Front Axle Part # | Rear Axle Part # |
|---|-------------------|------------------|
| 2018 and Newer Wrangler JL - 3.73 Ratio with Eaton ELocker®   | 10056042          | 10048757         |
| 2018 and Newer Wrangler JL - 4.10 Ratio with Eaton ELocker®   | 10056043          | 10048758         |
| 2018 and Newer Wrangler JL - 4.88 Ratio with Eaton ELocker®   | 10056032          | 10048764         |
| 2018 and Newer Wrangler JL - 5.38 Ratio with Eaton ELocker®   | 10056030          | 10048784         |
| 2018 and Newer Wrangler JL - 4.88 Ratio with ARB® Air Locker® | 10088914          | 10088916         |
| 2018 and Newer Wrangler JL - 5.38 Ratio with ARB® Air Locker® | 10088915          | 10088918         |

**RELATED PARTS**

| Description   | Spicer Part # |
|---|---------------|
| E-Locker Wire Harness Kit   | 10021771      |
| JL Front Driveshaft - 1350 Series (Long Slip)                         | 10097841      |
| JL 4 Door Rear Driveshaft - 1350 Series (Long Slip)                   | 10097842      |
| Performance Diff Cover - Nodular Iron (with hardware) - Front UD60    | 10024011      |
| Performance Diff Cover - Nodular Iron (with hardware) - Rear Dana 60™ | 10024090      |
| Steering Arm Kit - Front UD60™  | 10024009      |
| Wheel Joint - 1550/SPL70  | SPL70-4X      |
| Dana 60™ 35 Spline Drive Flange Kit                                   | 10028883      |
| Dana Blue Wheel Joint - 1550/SPL70                                    | SPL70-1550XC  |
| OE Integration Crate Axle E-Locker Wire Harness                       | 10056733      |

**THE ULTIMATE DANA 60™ AXLES for the JEEP® WRANGLER JL**

Dana stands ready to deliver the most popular drivetrain performance enhancements to match the excitement surrounding the introduction of the new Jeep Wrangler JL. Upgrading your JL to larger tires and heavy-duty off-road action requires the strength and durability of Ultimate Dana 60™ front and rear axles.



**#ULTIMATE DANA60™**



Built with genuine Spicer® products.



Scan here to learn more!

# #ULTIMATE DANA44 ADVANTEK



THE **ULTIMATE**  
**DANA 44™**  
**AdvanTEK®**  
 AXLES FOR THE JEEP® WRANGLER® JL



RELATED PARTS

| Description   | Spicer Part # |
|---|---------------|
| HD 1350 Series Front Driveshaft                     | 10097840      |
| HD 135 Series Rear Driveshaft - Dana 35™ AdvanTEK®  | 10097843      |
| HD 1350 Series Rear Driveshaft - Dana 44™ AdvanTEK® | 10097844      |



Built with genuine Spicer® products.



Scan here to learn more!

## THE ULTIMATE DANA 44™ ADVANTEK® AXLES for the JEEP® WRANGLER JL

For the first time ever, every Jeep® Wrangler vehicle will be offered with exclusive Dana AdvanTEK® axle technology, right off the line. AdvanTEK® technology offers improved strength and efficiency while reducing the overall size and weight of the axle. Dana now takes AdvanTEK to the next level, with the Ultimate Dana 44™ AdvanTEK® axle! Ultimate Dana 44™ AdvanTEK® axles deliver all the benefits of AdvanTEK® technology, paired with features like custom high-clearance housing that are designed to optimize extreme off-road performance.

**SPICER®**

**AdvanTEK®**  
 PERFORMANCE GEARING



Genuine Spicer® AdvanTEK® gearing inside

### THE ULTIMATE DANA 44™ ADVANTEK® CRATE AXLES (BOLT IN AXLE ASSY. FOR JL)

| Application   | Front Axle Part # |
|---|-------------------|
| 2018 and Newer Jeep Wrangler JL - Front 5.38 Ratio with Electric Locker | 10047719          |
| 2018 and Newer Jeep Wrangler JL - Front 5.13 Ratio with Electric Locker | 10047718          |
| 2018 and Newer Jeep Wrangler JL - Front 4.88 Ratio with Electric Locker | 10047717          |
| 2018 and Newer Jeep Wrangler JL - Front 4.56 Ratio with Electric Locker | 10047716          |
| 2018 and Newer Jeep Wrangler JL - Front 4.10 Ratio with Electric Locker | 10047715          |

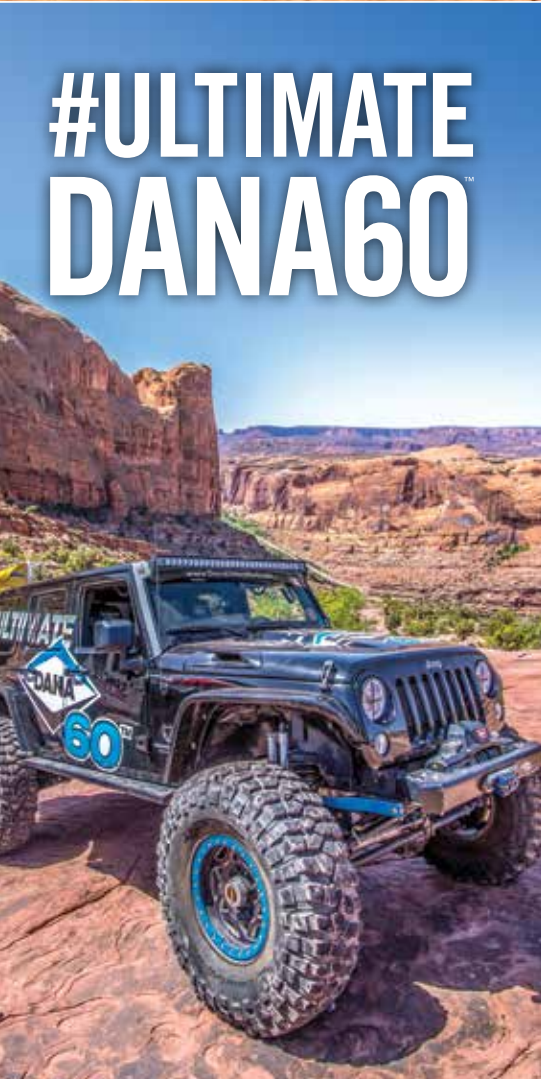

THE  
**ULTIMATE**

AXLES FOR THE  
**JEEP® WRANGLER® JK**

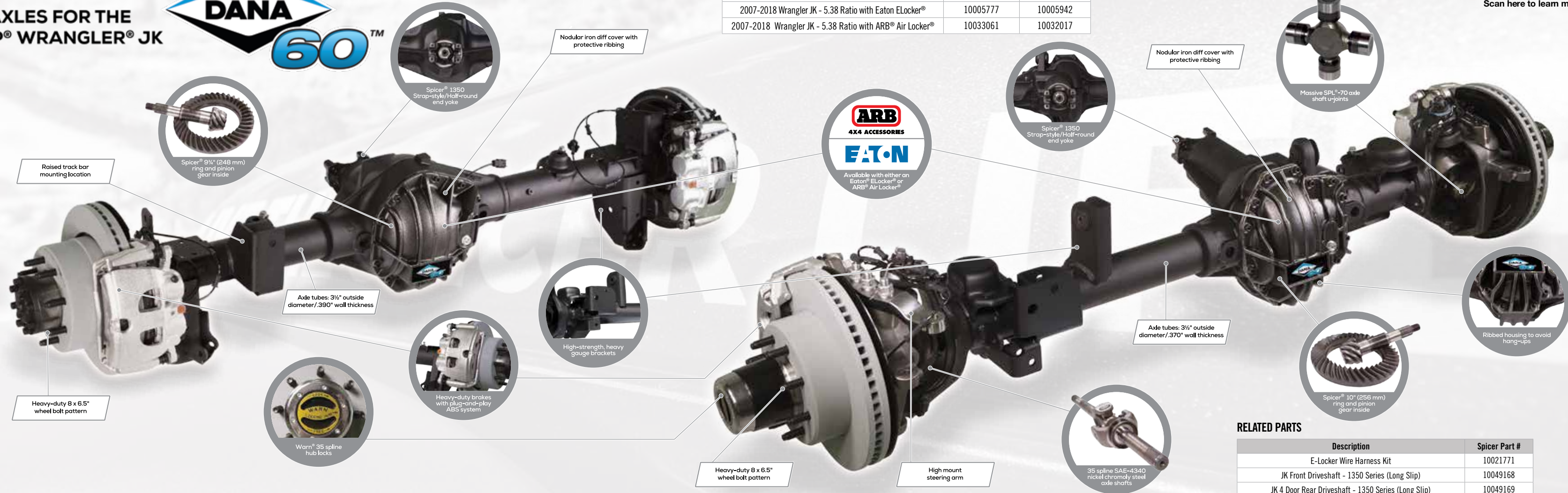

THE ULTIMATE DANA 60™ CRATE AXLES (BOLT IN AXLE ASSY. FOR JK)

| Application  | Front Axle Part # | Rear Axle Part # |
|--|-------------------|------------------|
| 2007-2018 Wrangler JK - 3.73 Ratio with Eaton ELocker®   | 10034267          | 10034269         |
| 2007-2018 Wrangler JK - 4.10 Ratio with Eaton ELocker®   | 10034268          | 10034270         |
| 2007-2018 Wrangler JK - 4.88 Ratio with Eaton ELocker®   | 10005778          | 2023612-1        |
| 2007-2018 Wrangler JK - 4.88 Ratio with ARB® Air Locker® | 10033062          | 10032016         |
| 2007-2018 Wrangler JK - 5.38 Ratio with Eaton ELocker®   | 10005777          | 10005942         |
| 2007-2018 Wrangler JK - 5.38 Ratio with ARB® Air Locker® | 10033061          | 10032017         |



THE ULTIMATE DANA 60™ AXLES for the JEEP® WRANGLER JK

As Jeep owners modify their axles for even better performance over rocks, across sand, and through mud, Dana has taken notice. That's why Ultimate Dana 60™ front and rear axles are built with the innovations that give you the confidence to take on the toughest terrain. Get added strength and durability, with increased ground clearance for larger tires.



RELATED PARTS

| Description   | Spicer Part # |
|---|---------------|
| E-Locker Wire Harness Kit   | 10021771      |
| JK Front Driveshaft - 1350 Series (Long Slip)                         | 10049168      |
| JK 4 Door Rear Driveshaft - 1350 Series (Long Slip)                   | 10049169      |
| Performance Diff Cover - Nodular Iron (with hardware) - Front UD60    | 10024011      |
| Performance Diff Cover - Nodular Iron (with hardware) - Rear Dana 60™ | 10024090      |
| Steering Arm Kit - Front UD60™  | 10024009      |
| Wheel Joint - 1550/SPL70  | SPL70-4X      |
| Dana 60™ 35 Spline Drive Flange Kit                                   | 10028883      |
| OE Integration Crate Axle E-Locker Wire Harness                       | 10056733      |

THE **ULTIMATE**  
**DANA 44™**  
 AXLES FOR THE  
**JEEP® WRANGLER® JK**

RELATED PARTS

| Description   | Spicer Part # |
|---|---------------|
| E-Locker Wire Harness Kit                                   | 10021771      |
| HD Front Driveshaft 0-2" Lift (with T-Case Yoke & Hardware) | 10018230      |
| HD Front Driveshaft 2-4" Lift (with T-Case Yoke & Hardware) | 10020345      |
| Blue Nodular Iron Differential Cover                        | 10048737      |
| Dana Blue Wheel Joint                                       | 5-7166XC      |
| OE Integration Crate Axle E-Locker Wire Harness             | 10056733      |

THE ULTIMATE DANA 44™ CRATE AXLES (BOLT IN AXLE ASSY. FOR JK)

| Application  | Front Axle Part # |
|--|-------------------|
| 2007-2018 Wrangler JK - Front - 3.73 Ratio with Electric Locker  | 10010519          |
| 2007-2018 Wrangler JK - Front - 3.73 Ratio with Std. Diff        | 10032861          |
| 2007-2018 Wrangler JK - Front - 3.73 Ratio with ARB® Air Locker® | 10048820          |
| 2007-2018 Wrangler JK - Front - 4.10 Ratio with Electric Locker  | 10010455          |
| 2007-2018 Wrangler JK - Front - 4.10 Ratio with Std. Diff        | 10032862          |
| 2007-2018 Wrangler JK - Front - 4.10 Ratio with ARB® Air Locker® | 10048821          |
| 2007-2018 Wrangler JK - Front - 4.56 Ratio with Electric Locker  | 10010520          |
| 2007-2018 Wrangler JK - Front - 4.56 Ratio with Std. Diff        | 10032863          |
| 2007-2018 Wrangler JK - Front - 4.56 Ratio with ARB® Air Locker® | 10048822          |
| 2007-2018 Wrangler JK - Front - 4.88 Ratio with Electric Locker  | 10010521          |
| 2007-2018 Wrangler JK - Front - 4.88 Ratio with Std. Diff        | 10032864          |
| 2007-2018 Wrangler JK - Front - 4.88 Ratio with ARB® Air Locker® | 10048823          |
| 2007-2018 Wrangler JK - Front - 5.13 Ratio with Electric Locker  | 10010522          |
| 2007-2018 Wrangler JK - Front - 5.13 Ratio with Std. Diff        | 10032865          |
| 2007-2018 Wrangler JK - Front - 5.13 Ratio with ARB® Air Locker® | 10048824          |
| 2007-2018 Wrangler JK - Front - 5.38 Ratio with Electric Locker  | 10010742          |
| 2007-2018 Wrangler JK - Front - 5.38 Ratio with Std. Diff        | 10032866          |
| 2007-2018 Wrangler JK - Front - 5.38 Ratio with ARB® Air Locker® | 10048825          |



THE ULTIMATE DANA 44™ FRONT AXLE for the JEEP® WRANGLER JK

Engineered for all Jeep® Wrangler JKs, 2007 to 2018, Ultimate Dana 44™ front axles feature a number of upgrades designed for added durability on the trail. Get a direct bolt-in solution that delivers increased strength wherever you take your vehicle.



Built with genuine Spicer® products.

#ULTIMATE  
 DANA44





## SPICER® DRIVESHAFTS for the JEEP® WRANGLER JK and JL

**Greater Strength. Less Vibration. Direct-Fit.**

- Featuring a thicker tube for added strength
- One-piece flange eliminates run-out and the need for an adapter
- Improved clearance to exhaust due to smaller diameter
- Slip length designed for a 2" to 4" vehicle lift
- Includes transfer case, half-round conversion yoke, and hardware

### HEAVY DUTY UPGRADE - 1350 SERIES DRIVESHAFT (FOR USE WITH ULTIMATE DANA 60™ AXLE FOR JL)

| Application                         | Position | Spicer Part # |
|-------------------------------------|----------|---------------|
| 2018 and Newer Wrangler JL          | Front    | 10097841      |
| 2018 and Newer Wrangler JL - 4 Door | Rear     | 10097842      |



### HEAVY DUTY UPGRADE - 1310 SERIES DRIVESHAFT

| Application                       | Position | Spicer Part # |
|-----------------------------------|----------|---------------|
| Jeep Wrangler JL (with 0-6" Lift) | Front    | 10020345      |
| Jeep Wrangler JK (with 0-2" Lift) | Front    | 10018230      |
| Jeep Wrangler JK (with 2-4" Lift) | Front    | 10020345      |

### HEAVY DUTY UPGRADE - 1350 SERIES DRIVESHAFT

| Application   | Position | Spicer Part # |
|---|----------|---------------|
| 2018 and Newer Wrangler JL with Dana 30™ Front Axle           | Front    | 10097839      |
| 2018 and Newer Wrangler JL with Dana 35™ AdvanTEK® Rear Axle  | Rear     | 10097843      |
| 2018 and Newer Wrangler JL with Dana 44™ AdvanTEK® Front Axle | Front    | 10097840      |
| 2018 and Newer Wrangler JL with Dana 44™ AdvanTEK® Rear Axle  | Rear     | 10097844      |

# DIRECT-FIT, BOLT-IN UPGRADE



All genuine Spicer driveshafts include a Spicer transfer case yoke and hardware for easy installation.

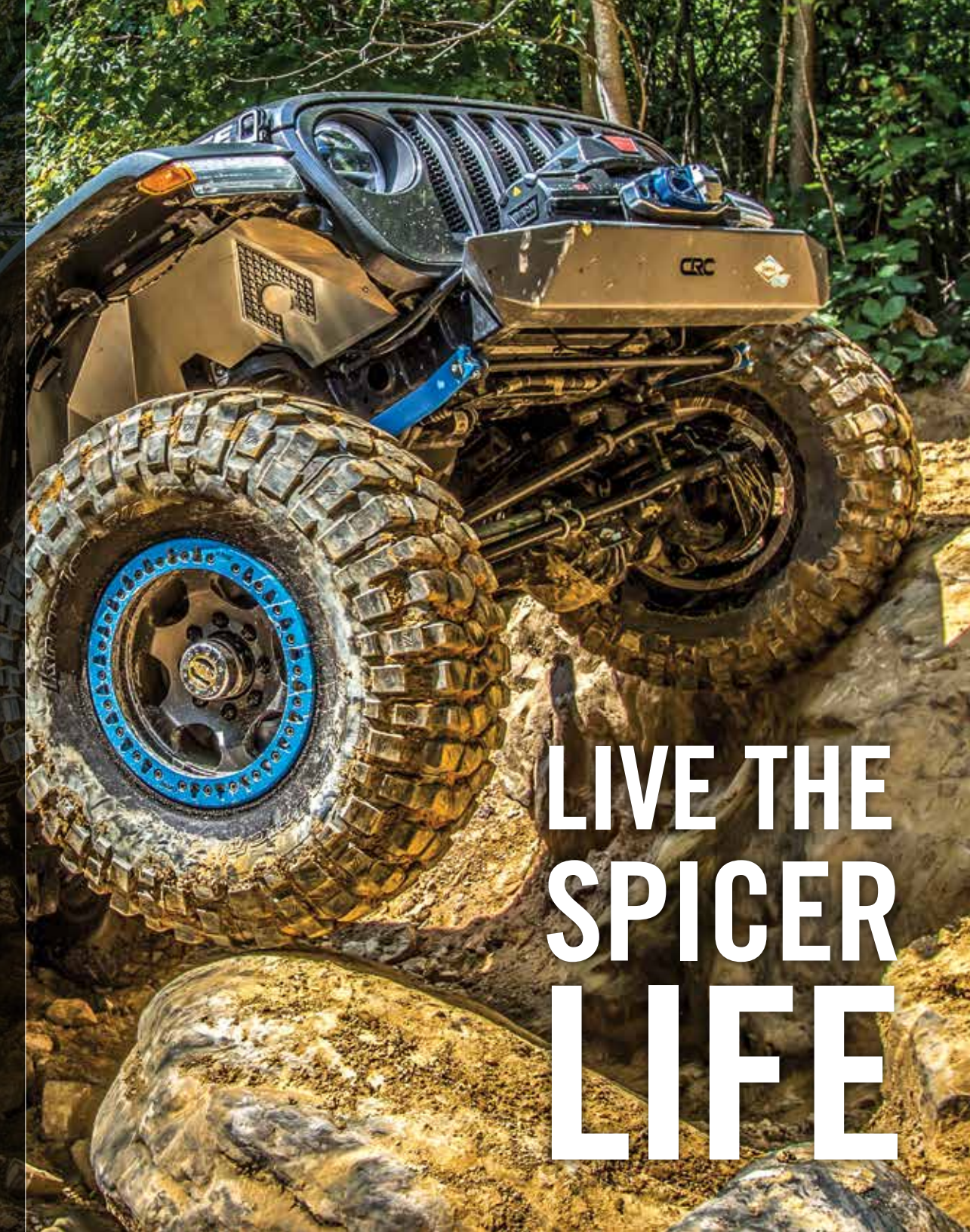

# LIVE THE SPICER LIFE



**BUILT FOR ULTIMATE PERFORMANCE**



Our SAE-4340 nickel chromoly axle shafts are engineered to exceed OE standards and meet the exacting demands of off-road.

**WHERE WE'RE GOING WE DON'T NEED ROADS**

## SPICER® NICKEL CHROMOLY AXLE SHAFTS for the JEEP® WRANGLER JK and JL

### The Metal Makes the Difference.

Hit the trail with the confidence that comes from knowing you are backed by the global leaders in driveline products. Engineered to deliver added strength and durability, these Spicer axle shafts are one more example of the innovations that we bring to performance applications.



#### 2018 AND NEWER WRANGLER JL

| Front Axle  | Series | Outer Part # | Outer Spline | Inner Right Part # | Inner Left Part # | Inner Spline | U-Joint Part # |
|-------------|--------|--------------|--------------|--------------------|-------------------|--------------|----------------|
| Dana 30™ JL | 1410   | 10044478     | 32           | 10044425           | 10044423          | 27           | 5-1410-3X      |

| Rear Axle          | Right Part # | Left Part # |
|--------------------|--------------|-------------|
| Dana 35™ AdvanTEK® | 10043051     | 10043051    |

| Front Axle                             | Series | Outer Part # | Outer Spline | Inner Right Part # | Inner Left Part # | Inner Spline | U-Joint Part # |
|--|--------|--------------|--------------|--------------------|-------------------|--------------|----------------|
| Dana 44™ AdvanTEK® Open Diff           | 1410   | 10044478     | 32           | 10044425           | 10044460          | 32           | 5-1410-3X      |
| Dana 44™ AdvanTEK® Wide Track E-Locker | 1410   | 10044478     | 32           | 10044466           | 10044464          | 32           | 5-1410-3X      |

| Rear Axle                              | Right Part # | Left Part # |
|--|--------------|-------------|
| Dana 44™ AdvanTEK® Open and Trac-Lok™  | 10043059     | 10043059    |
| Dana 44™ AdvanTEK® Wide Track E-Locker | 10043169     | 10043168    |

#### 2007-2018 WRANGLER JK (NON-RUBICON)

| Front Axle | Series | Outer Part # | Outer Spline | Inner Right Part # | Inner Left Part # | Inner Spline | U-Joint Part # |
|------------|--------|--------------|--------------|--------------------|-------------------|--------------|----------------|
| Dana 30™   | 1310   | 10014979     | 32           | 10014981           | 10014980          | 27           | 5-760X         |
| Dana 30™   | 1350   | 10015183     | 32           | 10015344           | 10015196          | 27           | 5-7166X        |

| Rear Axle | Right Part # | Left Part # |
|-----------|--------------|-------------|
| Dana 44™  | 10038830     | 10038830    |

#### 2007-2018 WRANGLER JK (RUBICON)

| Front Axle | Series | Outer Part # | Outer Spline | Inner Right Part # | Inner Left Part # | Inner Spline | U-Joint Part # |
|------------|--------|--------------|--------------|--------------------|-------------------|--------------|----------------|
| Dana 44™   | 1350   | 10015183     | 32           | 10015186           | 10015185          | 30           | 5-7166X        |
| Dana 44™   | 1350   | 10015183     | 32           | 10014983           | 10014982          | 30           | 5-7166X        |

| Rear Axle | Right Part # | Left Part # |
|-----------|--------------|-------------|
| Dana 44™  | 10038829     | 10038828    |

#### AXLE SHAFT ASSEMBLY KITS WRANGLER JL (INCLUDES LEFT AND RIGHT)

| Application               | Axle Model                                  | Location | Kit Description                                      | Spicer Part # |
|---------------------------|---|----------|--|---------------|
| 2018 and Newer JL         | Dana 35™ AdvanTEK                           | Rear     | Rear Right and Left Axle Shaft Kit                   | 10043084      |
| 2018 and Newer JL         | Dana 44™ AdvanTEK® Open and Trac-Lok™       | Rear     | Rear Right and Left Axle Shaft Kit                   | 10043086      |
| 2018 and Newer JL         | Dana 44™ AdvanTEK® Wide Track E-Locker      | Rear     | Rear Right and Left Axle Shaft Kit                   | 10043179      |
| 2018 and Newer JL         | Dana 30™                                    | Front    | Front Right and Left Axle Shaft Kit with FAD Removal | 10044417      |
| 2018 and Newer JL         | Dana 30™                                    | Front    | Front Right and Left Axle Shaft Kit                  | 10045077      |
| 2018 and Newer JL         | Dana 44™ AdvanTEK® Open Differential        | Front    | Front Right and Left Axle Shaft Kit with FAD Removal | 10044469      |
| 2018 and Newer JL         | Dana 44™ AdvanTEK® Wide Track with E-Locker | Front    | Front Right and Left Axle Shaft Kit with FAD Removal | 10044474      |
| 2018 and Newer JL         | Dana 44™ AdvanTEK® Open Differential        | Front    | Front Right and Left Axle Shaft Kit                  | 10044458      |
| 2018 and Newer JL Rubicon | Dana 44™ AdvanTEK® Wide Track with E-Locker | Front    | Front Right and Left Axle Shaft Kit                  | 10044459      |

|                 | Spicer Part # |
|-----------------|---------------|
| FAD Removal Kit | 10045078      |

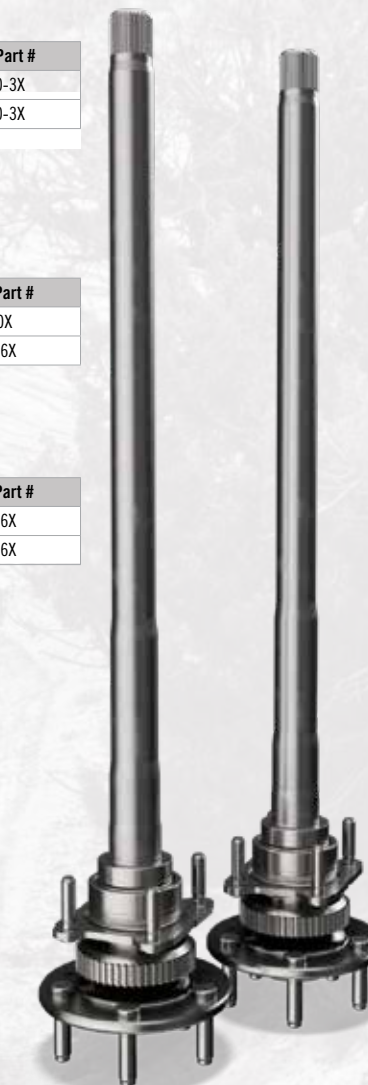

# SPICER® RING & PINION GEARING for the JEEP® WRANGLER JK

Quiet, Durable, Easy to Set Up Gearing for the Dana 30™ and Dana 44™ Axles.

Get the benefits of precision-machined gearing for genuine Dana axles, including a smoother, quieter ride and up to double the life of non-genuine parts. Our Spicer **Differential Bearing Install Kits** and **Differential Bearing Master Overhaul Kits** save you money, downtime, and aggravation by offering the parts you need when you need them.

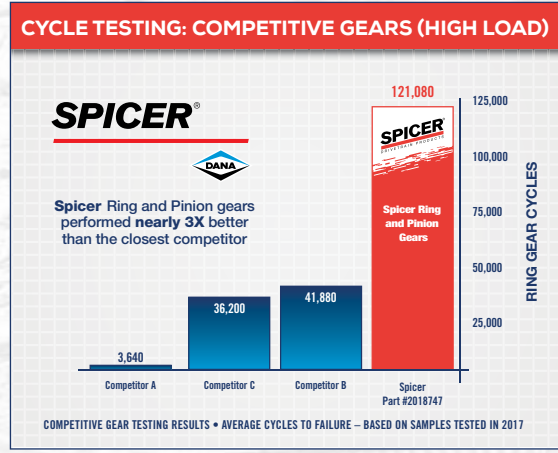
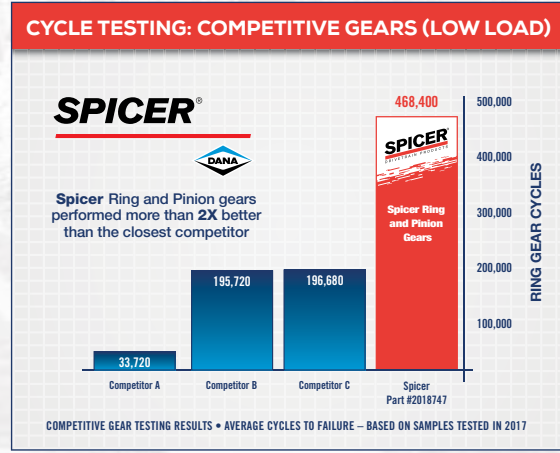

During fatigue tests, each gear is installed in a production axle attached to a dyno. The axle runs on the dyno until the gear fractures. The high-load test simulates a loaded vehicle going uphill or carrying extra capacity such as a trailer. The low-load test simulates everyday driving at an accelerated rate. Under high-load conditions, Spicer ring and pinion gears lasted an average of 121,080 cycles—nearly three times as many cycles as the closest competitor. And under low-load conditions, Spicer ring and pinion gears performed more than twice as many cycles as the competition!

## 2007-2018 JEEP® WRANGLER JK (NON-RUBICON)

| Front Axle | Ratio | Differential Bearing Rebuild Kits |            |                    |                   |
|------------|-------|-----------------------------------|------------|--------------------|-------------------|
|            |       | Spicer Part #                     | SVL Part # | Install Kit Part # | Master Kit Part # |
| Dana 30™   | 3.73  | 2005021-5*                        | -          | 2017366            | 2017378           |
| Dana 30™   | 4.10  | 2005027-5*                        | -          | 2017366            | 2017378           |
| Dana 30™   | 4.56  | 10026645                          | 10010173   | 2017366            | 2017378           |
| Dana 30™   | 4.88  | 10026639                          | 10010176   | 2017366            | 2017378           |
| Dana 30™   | 5.13  | 10026642                          | 10010179   | 2017366            | 2017378           |
| Rear Axle  | Ratio | Spicer Part #                     | SVL Part # | Install Kit Part # | Master Kit Part # |
| Dana 44™   | 3.21  | 2007774                           | -          | 2017086            | 2017109**         |
| Dana 44™   | 3.73  | 2008688                           | -          | 2017086            | 2017109**         |
| Dana 44™   | 4.10  | 2007772                           | -          | 2017086            | 2017109**         |
| Dana 44™   | 4.56  | 2018737                           | 2020746    | 2017086            | 2017109**         |
| Dana 44™   | 4.88  | 2018747                           | 2020749    | 2017086            | 2017109**         |
| Dana 44™   | 5.13  | 2018756                           | 2020752    | 2017086            | 2017109**         |
| Dana 44™   | 5.38  | 10027182                          | 10012316   | 2017086            | 2017109**         |

## 2007-2018 JEEP® WRANGLER JK (RUBICON)

| Front Axle | Ratio | Differential Bearing Rebuild Kits |            |                    |                   |
|------------|-------|-----------------------------------|------------|--------------------|-------------------|
|            |       | Spicer Part #                     | SVL Part # | Install Kit Part # | Master Kit Part # |
| Dana 44™   | 3.73  | 2013742-5*                        | -          | 2017088            | 2017106           |
| Dana 44™   | 4.10  | 2005024-5*                        | -          | 2017088            | 2017106           |
| Dana 44™   | 4.56  | 2019746                           | 10010200   | 2017088            | 2017106           |
| Dana 44™   | 4.88  | 2019749                           | 10010203   | 2017088            | 2017106           |
| Dana 44™   | 5.13  | 2019752                           | 10010206   | 2017088            | 2017106           |
| Dana 44™   | 5.38  | 10010738                          | 10010209   | 2017088            | 2017106           |
| Rear Axle  | Ratio | Spicer Part #                     | SVL Part # | Install Kit Part # | Master Kit Part # |
| Dana 44™   | 3.21  | 2007774                           | -          | 2017086            | 2017109**         |
| Dana 44™   | 3.73  | 2008688                           | -          | 2017086            | 2017109**         |
| Dana 44™   | 4.10  | 2007772                           | -          | 2017086            | 2017109**         |
| Dana 44™   | 4.56  | 2018737                           | 2020746    | 2017086            | 2017109**         |
| Dana 44™   | 4.88  | 2018747                           | 2020749    | 2017086            | 2017109**         |
| Dana 44™   | 5.13  | 2018756                           | 2020752    | 2017086            | 2017109**         |
| Dana 44™   | 5.38  | 10027182                          | 10012316   | 2017086            | 2017109**         |

\* Includes Ring Gear Bolts & Pinion Nut \*\* Fits 2008 & Newer Wrangler JK. 2007 Model Year Uses PN# 2017102

# HEAT TREATMENT FACE HOBBING SHOT PEENING LAPPING



# FOR THOSE ABOUT TO ROCK

These are the processes that differentiate us from the competition. To learn what makes a Spicer quality part, visit us on the web at [www.SpicerParts.com/WhatsTheDiff](http://www.SpicerParts.com/WhatsTheDiff).



**GEAR UP FOR THE GREAT OUTDOORS.**

# ROCK STEADY PERFORMANCE



Built with a smaller, more durable 220mm ring gear, Spicer® AdvanTEK® gives Jeep enthusiasts the power to handle even the most extreme off-road conditions.

# SPICER®

**AdvanTEK®**   
PERFORMANCE GEARING

## SPICER® ADVANTEK® GEARING for the JEEP® WRANGLER JL

For the first time ever, every Jeep Wrangler JL vehicle will be offered with exclusive Dana® AdvanTEK® technology, right off the line. Only Dana delivers the technology and performance of AdvanTEK® gearing – available for the Dana 35™ and Dana 44™. Trust them to provide greater power density and fuel efficiency than similar offerings, while reducing driveline weight with lighter, higher-strength materials and advanced Spicer® AdvanTEK® technology.



Made in USA



### 2018 AND NEWER JEEP® WRANGLER JL

|   | Differential Bearing Rebuild Kits |          |               |                    |                   |
|---|-----------------------------------|----------|---------------|--------------------|-------------------|
|   | Front Axle                        | Ratio    | Spicer Part # | Install Kit Part # | Master Kit Part # |
| Rubicon and Select Sport or Sahara Models | Dana 44™ AdvanTEK®                | 3.73     | 10046055      | 10040468           | 10040469          |
|   | Dana 44™ AdvanTEK®                | 4.10     | 10048087      | 10040468           | 10040469          |
|   | Dana 44™ AdvanTEK®                | 4.56     | 10050939      | 10040468           | 10040469          |
|   | Dana 44™ AdvanTEK®                | 4.88     | 10051746      | 10040468           | 10040469          |
|   | Dana 44™ AdvanTEK®                | 5.13     | 10051004      | 10040468           | 10040469          |
|   | Dana 44™ AdvanTEK®                | 5.38     | 10050979      | 10040468           | 10040469          |
|   | Rear Axle                         | Ratio    | Spicer Part # | Install Kit Part # | Master Kit Part # |
|   | Dana 44™ AdvanTEK®                | 3.43     | 10062926      | 10040477           | 10040478          |
|   | Dana 44™ AdvanTEK®                | 3.73     | 10062017      | 10040477           | 10040478          |
|   | Dana 44™ AdvanTEK®                | 4.10     | 10062033      | 10040477           | 10040478          |
| Dana 44™ AdvanTEK®                        | 4.56                              | 10067141 | 10040477      | 10040478           |                   |
| Dana 44™ AdvanTEK®                        | 4.88                              | 10073110 | 10040477      | 10040478           |                   |
| Dana 44™ AdvanTEK®                        | 5.13                              | 10067157 | 10040477      | 10040478           |                   |
| Dana 44™ AdvanTEK®                        | 5.38                              | 10067204 | 10040477      | 10040478           |                   |
| Base Sport or Sahara Models               | Front Axle                        | Ratio    | Spicer Part # | Install Kit Part # | Master Kit Part # |
|   | Dana 30™                          | 3.45     | 10006253      | 10040312           | 10040313          |
|   | Dana 30™                          | 4.10     | 2005027-5*    | 10040312           | 10040313          |
|   | Dana 30™                          | 4.56     | 10026645      | 10040312           | 10040313          |
|   | Dana 30™                          | 4.88     | 10026639      | 10040312           | 10040313          |
|   | Dana 30™                          | 5.13     | 10026642      | 10040312           | 10040313          |
|   | Rear Axle                         | Ratio    | Spicer Part # | Install Kit Part # | Master Kit Part # |
|   | Dana 35™ AdvanTEK®                | 3.45     | 10060460      | 10040451           | 10040452          |
|   | Dana 35™ AdvanTEK®                | 4.10     | 10095819      | 10040451           | 10040452          |
|   | Dana 35™ AdvanTEK®                | 4.56     | 10067221      | 10040451           | 10040452          |
| Dana 35™ AdvanTEK®                        | 4.88                              | 10067231 | 10040451      | 10040452           |                   |
| Dana 35™ AdvanTEK®                        | 5.13                              | 10067244 | 10040451      | 10040452           |                   |

\* Includes Ring Gear Bolts & Pinion Nut

@SpicerParts

DanaAftermarket.com

#SpicerParts



## SPICER® AXLE SHAFT U-JOINTS & DRIVESHAFT U-JOINT PERFORMANCE PACKS for the JEEP® WRANGLER

### The Ultimate U-Joints for Premium Performance.

No matter what conditions you throw at your vehicle, Spicer Life Series® and Spicer 10 Series™ u-joints deliver.

- Performance packs provide every u-joint needed for repair on the trail
- **Journal Cross.** Engineered with a solid cold-formed body
- **Lubrication Options.** Available in greaseable or non-greaseable options
- **Bearing Cups.** Heat-treated for strength and precision ground and case-hardened for durability
- **Multi-lip Seal.** Keep grease in and contaminants out
- **Thrust Washers.** Prevent wear by eliminating metal-to-metal contact
- For more application information please visit [www.SpicerParts.com/Identify](http://www.SpicerParts.com/Identify)
- For u-joint testing data, please visit [www.SpicerParts.com/WhatsTheDiff](http://www.SpicerParts.com/WhatsTheDiff)



### AXLE SHAFT U-JOINTS

| Description   | Spicer Part # |
|---|---------------|
| Premium Spicer Life Series® (1350 Non-Greaseable)               | 5-7166X       |
| Premium Spicer Life Series® (1310 Non-Greaseable)               | 5-760X        |
| Genuine Spicer (1310 Greaseable)                                | 5-260X        |
| Premium Spicer Life Series (1410 Non-Greaseable)                | 5-1410-3X     |
| Premium Spicer Life Series® (SPL®70/1550 Non-Greaseable)        | SPL70-4X      |
| Premium Spicer Life Series® - Blue (1310 Non-Greaseable)        | 5-760XC       |
| Premium Spicer Life Series® - Blue (1350 Non-Greaseable)        | 5-7166XC      |
| Premium Spicer Life Series® - Blue (SPL70®/1550 Non-Greaseable) | SPL70-1550XC  |

### SPICER LIFE SERIES® DRIVESHAFT U-JOINT PERFORMANCE PACKS

| Application   | Spicer Part # |
|---|---------------|
| 2007-11 JK w/ Aftermarket 1310 Driveshafts with CV Front Driveshaft | SPL® 1014JK   |
| 2007-11 JK w/ Aftermarket 1350 Driveshafts with CV Front Driveshaft | SPL® 1029JK   |
| 2012-18 JK w/ Aftermarket 1310 Driveshafts with CV Front Driveshaft | SPL® 1028JK   |
| 2012-18 JK w/ Aftermarket 1350 Driveshafts with CV Front Driveshaft | SPL® 1030JK   |

## SPICER® ULTRA-PREMIUM SYNTHETIC GREASE

Don't Skimp on the Lube That Keeps Everything Running Smoothly.

- The only synthetic lubricant engineered to complement genuine Spicer® u-joints
- Increases bearing life by more than 30%
- Made from calcium sulfonate for superior performance
- Excellent load-carrying ability, wear resistance, and protection against corrosion
- Available in 14-ounce tubes or 1-gallon tubs

| Description   | Spicer Part # |
|---------------|---------------|
| 14-Ounce Tube | SPL® 1051     |
| 1-Gallon Tub  | SPL® 1052     |



# TESTED. PROVEN. TRUSTED. DRIVEN.

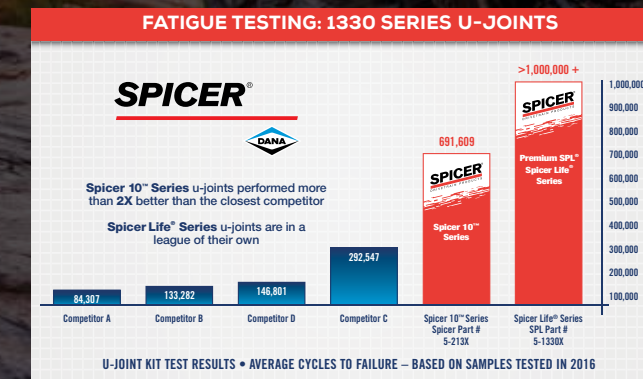
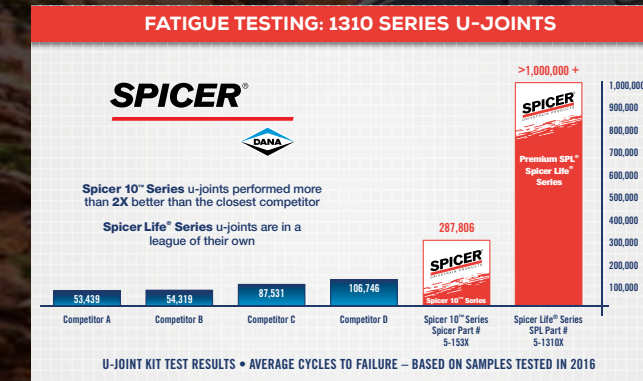

# WHERE PROCESS MEETS PERFORMANCE

Spicer universal joints outperform the competition! For more information, visit [SpicerParts.com/WhatsTheDiff](http://SpicerParts.com/WhatsTheDiff).

## SPICER® PERFORMANCE ADJUSTABLE SHOCKS for the JEEP® WRANGLER JK

Hand-Built in the USA by Walker Evans Racing

For the first time, you can get the ride that made the legend. Walker Evans Racing uses only the finest domestic alloys to hand-build these direct-fit shock absorbers. Manufactured with pride in Riverside, California, these rebuildable shocks deliver championship quality on the road and off. Trust the names that people have turned to for decades: Walker Evans Racing and Spicer. **Shocks are sold individually.**

- Braided stainless remote lines withstand abrasion and heat
- Billet aluminum remote reservoir brackets hold tight in the toughest circumstances
- Progressive application-specific valve stacks offer unparalleled ride quality and performance
- 16-position compression adjuster delivers 250% range of dampening force, easily adjusting for any street or trail conditions



### SPICER® PERFORMANCE ADJUSTABLE SHOCKS

| Category                      | Spicer Part # | Application Summary                           |
|-------------------------------|---------------|---|
| Performance Adjustable Shocks | 2023594       | Jeep Wrangler JK with 3-5" Lift (Left/Front)  |
| Performance Adjustable Shocks | 2023595       | Jeep Wrangler JK with 3-5" Lift (Left/Rear)   |
| Performance Adjustable Shocks | 2023594       | Jeep Wrangler JK with 3-5" Lift (Right/Front) |
| Performance Adjustable Shocks | 2023595       | Jeep Wrangler JK with 3-5" Lift (Right/Rear)  |



# NO ROADS. NO LIMITS.

## SPICER® INNER GEAR KITS for the JEEP® WRANGLER JK and JL Near-Net Forged for Longer Life in Dana Axles.

- Everything you need to rebuild your differential case
- Inner gear kit engineered to Dana specifications
- Forged to ensure greater strength and increased durability, without the stress risers that come from cutting gears



### CARRIER CASE INNER GEAR KITS FOR JL

| Application Summary | Position | Axle Model         | Description                               | Spicer Part # |
|---------------------|----------|--------------------|---|---------------|
| 2018 and Newer JL   | Front    | Dana 30™           | Standard Diff                             | 10062492      |
| 2018 and Newer JL   | Front    | Dana 44™ AdvanTEK® | Standard Diff                             | 10067836      |
| 2018 and Newer JL   | Rear     | Dana 35™ AdvanTEK® | Standard Diff                             | 10063481      |
| 2018 and Newer JL   | Rear     | Dana 44™ AdvanTEK® | Standard Diff                             | 10071981      |
| 2018 and Newer JL   | Rear     | Dana 44™ AdvanTEK® | Trac-Lok™ Limited Slip                    | 10071921      |
| 2018 and Newer JL   | Rear     | Dana 44™ AdvanTEK® | Trac-Lok™ Limited Slip Clutch & Plate Kit | 10071924      |

### CARRIER CASE INNER GEAR KITS FOR JK

| Application Summary               | Position | Axle Model | Description                               | Spicer Part # |
|-----------------------------------|----------|------------|---|---------------|
| 2007-2018 Wrangler JK Non-Rubicon | Front    | Dana 30™   | Standard Diff                             | 2005962       |
| 2007-2018 Wrangler JK Non-Rubicon | Rear     | Dana 44™   | Standard Diff                             | 2009155       |
| 2007-2018 Wrangler JK Non-Rubicon | Rear     | Dana 44™   | Trac-Lok™ Limited Slip Clutch & Plate Kit | 2007326       |

## DANA 60™ 35 SPLINE DRIVE FLANGE KIT for the JEEP® WRANGLER JK and JL

Dual Heat Treated and Engineered from SAE-4340 Nickel Chromoly Steel

### Kit contents:

- 2 dual heat treated SAE-4340 nickel chromoly steel drive flanges – 35 spline
- 2 Dana 60™ etched aluminum drive flange covers (black finish)
- 8 stainless steel cover screws
- 2 steel retaining spacer rings
- 2 large o-rings
- 2 axle clip rings



| Axle Model | Spline Count | Cover Color | Description      | Spicer Part # |
|------------|--------------|-------------|------------------|---------------|
| Dana 60™   | 35 Spline    | Black       | Drive Flange Kit | 10028883      |



# BUILT FOR PEAK PERFORMANCE.



### NODULAR IRON - PERFORMANCE - JK

| Application Summary               | Axle Model | Position | Description  | Spicer Part # |
|-----------------------------------|------------|----------|--|---------------|
| 2007-2018 Wrangler JK Non-Rubicon | Dana 30™   | Front    | Gray Nodular Iron - Performance (with hardware & Performance Gasket) | 10023534      |
| 2007-2018 Wrangler JK Non-Rubicon | Dana 30™   | Front    | Blue Nodular Iron - Performance (with hardware & Performance Gasket) | 10048737      |
| 2007-2018 Wrangler JK Rubicon     | Dana 44™   | Front    | Gray Nodular Iron - Performance (with hardware)                      | 10023536      |
| 2007-2018 Wrangler JK Rubicon     | Dana 44™   | Front    | Blue Nodular Iron - Performance (with hardware)                      | 10048739      |
| 2007-2018 Wrangler JK             | Dana 44™   | Rear     | Gray Nodular Iron - Performance (with hardware)                      | 10023536      |
| 2007-2018 Wrangler JK             | Dana 44™   | Rear     | Blue Nodular Iron - Performance (with hardware)                      | 10048739      |

### STAMPED STEEL - GENUINE REPLACEMENT - JK

| Application Summary               | Axle Model | Position | Description                             | Spicer Part # |
|-----------------------------------|------------|----------|---|---------------|
| 2007-2018 Wrangler JK Non-Rubicon | Dana 30™   | Front    | Stamped Steel Cover Kit (with hardware) | 2007353       |
| 2007-2018 Wrangler JK Rubicon     | Dana 44™   | Front    | Stamped Steel Cover Kit (with hardware) | 708175        |
| 2007-2018 Up Wrangler JK          | Dana 44™   | Rear     | Stamped Steel Cover Kit (with hardware) | 707111X       |

### NODULAR IRON - PERFORMANCE - JL

| Application Summary | Axle Model         | Position | Description                                     | Spicer Part # |
|---------------------|--------------------|----------|---|---------------|
| 2018 and Newer JL   | Dana 30™           | Front    | Gray Nodular Iron - Performance (with hardware) | 10040640      |
| 2018 and Newer JL   | Dana 30™           | Front    | Blue Nodular Iron - Performance (with hardware) | 10053465      |
| 2018 and Newer JL   | Dana 35™ AdvanTEK® | Rear     | Gray Nodular Iron - Performance (with hardware) | 10044349      |
| 2018 and Newer JL   | Dana 35™ AdvanTEK® | Rear     | Blue Nodular Iron - Performance (with hardware) | 10053467      |
| 2018 and Newer JL   | Dana 44™ AdvanTEK® | Front    | Gray Nodular Iron - Performance (with hardware) | 10044799      |
| 2018 and Newer JL   | Dana 44™ AdvanTEK® | Front    | Blue Nodular Iron - Performance (with hardware) | 10053466      |
| 2018 and Newer JL   | Dana 44™ AdvanTEK® | Rear     | Gray Nodular Iron - Performance (with hardware) | 10040651      |
| 2018 and Newer JL   | Dana 44™ AdvanTEK® | Rear     | Blue Nodular Iron - Performance (with hardware) | 10053468      |

### STAMPED STEEL - GENUINE REPLACEMENT - JL

| Application Summary | Axle Model         | Position | Description                             | Spicer Part # |
|---------------------|--------------------|----------|---|---------------|
| 2018 and Newer JL   | Dana 35™ AdvanTEK® | Rear     | Stamped Steel Cover Kit (with hardware) | 10063376      |
| 2018 and Newer JL   | Dana 44™ AdvanTEK® | Rear     | Stamped Steel Cover Kit (with hardware) | 10071956      |

## SPICER® PERFORMANCE DIFFERENTIAL COVERS for the JEEP® WRANGLER JK and JL

Wherever You Take Your Vehicle, We Have You Covered.

- Designed with an aggressive look to match trail-ready strength
- Manufactured from high-strength nodular iron
- Built with ribbing to protect components off-road
- Ensures greater housing rigidity
- Enhances the look of your undercarriage
- Raised fill plug for increased fluid capacity on high pinion angles
- Includes hardware and drain plug

## SPICER® PERFORMANCE DIFFERENTIAL GASKETS for the JEEP® WRANGLER JK

Easily Installed. Instantly Sealed.

Tired of using paper differential gaskets? Spicer has the solution.

- High-performance gaskets for maximum durability
- Easy repair when you are in the field
- Anti-stick coating on the outside
- Woven steel core at the center
- Does not require RTV or other silicone-based sealant
- Reusable for added convenience

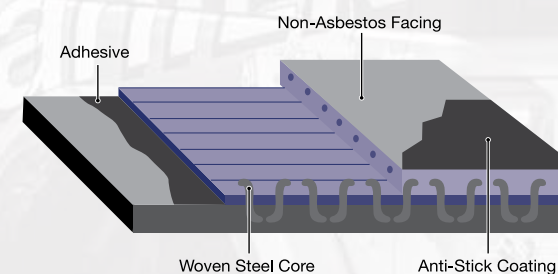
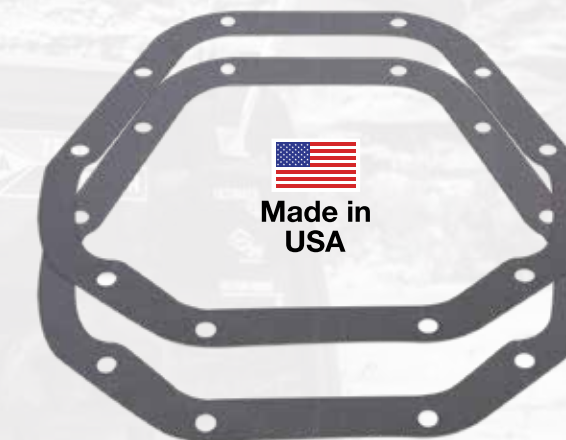

### DIFFERENTIAL COVER GASKETS

| Application Summary   | Axle Model | Description                 | Spicer Part # |
|-----------------------|------------|-----------------------------|---------------|
| 2007-2018 Wrangler JK | Dana 30™   | High Performance / Reusable | RD52001       |
| 2007-2018 Wrangler JK | Dana 30™   | Genuine Spicer OE-Style     | 34684         |
| 2007-2018 Wrangler JK | Dana 44™   | High Performance / Reusable | RD52000       |
| 2007-2018 Wrangler JK | Dana 44™   | Genuine Spicer OE-Style     | 34685         |

## SPICER® DIFFERENTIAL CARRIER CASES for the JEEP® WRANGLER JK and JL

Strength and Durability Across Multiple Configurations.



### DIFFERENTIAL CARRIER CASES FOR JL

| Application Summary             | Position | Axle Model         | Description    | Spicer Part # |
|---------------------------------|----------|--------------------|----------------|---------------|
| 2018 and Newer Jeep Wrangler JL | Front    | Dana 30™           | Standard Diff  | 10062383      |
| 2018 and Newer Jeep Wrangler JL | Rear     | Dana 35™ AdvanTEK® | Standard Diff  | 10063459      |
| 2018 and Newer Jeep Wrangler JL | Front    | Dana 44™ AdvanTEK® | Standard Dif   | 10067838      |
| 2018 and Newer Jeep Wrangler JL | Rear     | Dana 44™ AdvanTEK® | Trac-Lok™ Diff | 10071926      |

### DIFFERENTIAL CARRIER CASES FOR JK

| Application Summary               | Position   | Axle Model | Description               | Spicer Part # |
|-----------------------------------|------------|------------|---------------------------|---------------|
| 2007-2018 Wrangler JK Non-Rubicon | Front      | Dana 30™   | Standard Diff 3.73 & Up   | 2005974       |
| 2007-2018 Wrangler JK Non-Rubicon | Front      | Dana 30™   | Standard Diff 3.55 & Down | 2005961       |
| 2007-2018 Wrangler JK Rubicon     | Front      | Dana 44™   | Electric Locking Diff     | 2007503       |
| 2007-2018 Wrangler JK Non-Rubicon | Rear       | Dana 44™   | Standard Diff             | 2008572       |
| 2007-2018 Wrangler JK Non-Rubicon | Rear       | Dana 44™   | Trac-Lok™ Limited Slip    | 2008571       |
| 2007-2018 Wrangler JK Rubicon     | Rear       | Dana 44™   | Electric Locking Diff     | 2008559       |
| 2007-2018 Wrangler JK Rubicon     | Front/Rear | Dana 44™   | E-Locker Solenoid Assy.   | 2005193       |





# WHERE THE RUBBER LEAVES THE ROAD.

## SPICER® FRONT and REAR AXLE SHAFTS for the JEEP® WRANGLER JK and JL

### Upgraded Dana 30™ and Dana 44™ Axle Shafts for Larger Tires.

Today's Jeep owners are customizing their vehicles with larger tires that stand up to rough terrain. They want larger universal joints and an even stronger axle shaft for their Dana 30™ and Dana 44™ axles. These upgraded front axle shafts deliver with these design improvements:



**Made in USA**

#### U-joint size increased from 1310 to 1350 series

- 25% higher yield strength
- U-joint sealing package upgraded to Spicer Life Series®

#### Unparalleled strength and longer life

- Fatigue life improved by 300%
- 2000% improvement in high-angle fatigue life



#### Upgrades made to Dana 30 and Dana 44 axles

- Designed for larger tires and off-road use

#### Outer stub design re-engineered for added strength

- Improved snap retention for increased shock loading
- Material added to yoke ears and removed from body to equalize deflection through yoke and reduce bearing cap spinning
- Micro-alloy improves strength of shaft
- Statistically controlled heat treatment ensures proper hardness

#### 2007-2018 WRANGLER JK (NON RUBICON)

| Front Axle | Right Part # | Left Part # |
|------------|--------------|-------------|
| Dana 30™   | 2014616-2    | 2014616-1   |
| Rear Axle  | Right Part # | Left Part # |
| Dana 44™   | 2004449-1    | 2004449-1   |

#### 2007-2018 WRANGLER JK (RUBICON)

| Front Axle | Right Part # | Left Part # |
|------------|--------------|-------------|
| Dana 44™   | 2014169-2    | 2014169-1   |
| Rear Axle  | Right Part # | Left Part # |
| Dana 44™   | 2004785-3    | 2004785-2   |

#### 2018 AND NEWER JL

| Front Axle   | Right Part # | Left Part # |
|--|--------------|-------------|
| Dana 30™   | 10025729     | 10025732    |
| Dana 44™ AdvanTEK® Standard Diff                     | 10025729     | 10025731    |
| Dana 44™ AdvanTEK® Standard Diff Wide Track E-Locker | 10027942     | 10027941    |

## SPICER® E-LOCKER SOLENOID for the JEEP® WRANGLER JK

### Replace Your Failed Component—On Demand.

Spicer E-Locker solenoids deliver the quality that original equipment manufacturers demand. It's the same quality Jeep enthusiasts depend on to take on any obstacle that crosses their path.

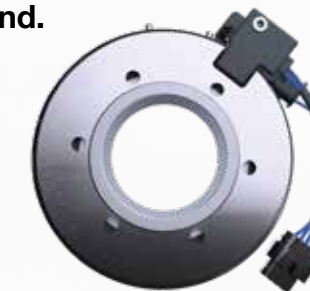

## SPICER® BEARING KITS for the JEEP® WRANGLER JK and JL

### Not All Bearings Are Created Equal.



#### DANA 44™ E-LOCKER SOLENOID

| Year      | Make | Model                                       | Axle     | Location | Spicer Part # |
|-----------|------|---|----------|----------|---------------|
| 2007-2018 | Jeep | Wrangler JK Rubicon w/OEM Electronic Locker | Dana 44™ | F/R      | 2005193       |

#### BEARING KITS FOR JK

| Application Summary               | Axle Model | Position | Std. Diff Rebuild Kit Part # | Master Overhaul Kit Part # |
|-----------------------------------|------------|----------|------------------------------|----------------------------|
| 2007-2018 Wrangler JK Non-Rubicon | Dana 30™   | Front    | 2017366                      | 2017378                    |
| 2007-2018 Wrangler JK Rubicon     | Dana 44™   | Front    | 2017088                      | 2017106                    |
| 2007-2018 Wrangler JK Non-Rubicon | Dana 44™   | Rear     | 2017086                      | 2017102                    |
| 2007-2018 Wrangler JK Rubicon     | Dana 44™   | Rear     | 2017087                      | 2017103                    |
| 2007-2018 Wrangler JK Non-Rubicon | Dana 44™   | Rear     | 2017086                      | 2017109                    |
| 2007-2018 Wrangler JK Rubicon     | Dana 44™   | Rear     | 2017087                      | 2017110                    |

#### BEARING KITS FOR JL

| Application Summary             | Axle Model         | Position | Std. Diff Rebuild Kit Part # | Master Overhaul Kit Part # |
|---------------------------------|--------------------|----------|------------------------------|----------------------------|
| 2018 and Newer Jeep Wrangler JL | Dana 30™           | Front    | 10040312                     | 10040313                   |
| 2018 and Newer Jeep Wrangler JL | Dana 35™ AdvanTEK® | Rear     | 10040451                     | 10040452                   |
| 2018 and Newer Jeep Wrangler JL | Dana 44™ AdvanTEK® | Front    | 10040468                     | 10040469                   |
| 2018 and Newer Jeep Wrangler JL | Dana 44™ AdvanTEK® | Rear     | 10040477                     | 10040478                   |





## SPICER® RING & PINION UPGRADE BUNDLES - 2018 JEEP® and NEWER WRANGLER JL with DANA 44™ ADVANTEK®

The legendary Jeep story continues with the introduction of the Wrangler JL – and once again, Dana is a trusted partner as both the OE and aftermarket drivetrain components manufacturer. Upgrading to an Ultimate Dana 44™ axle on your JL? You'll need to upgrade your rear axle as well. Look for your ratio here, and then discover the additional components you need to finish the job. Once you increase your tire size, you'll need to ensure the correct axle ratio and gear ratio to help you achieve the amount of torque and optimal mileage you're looking for. Check out our calculators at [www.SpicerParts.com/Calculators](http://www.SpicerParts.com/Calculators) today.

### SPICER® BUNDLE FOR THE JL RUBICON 3.73 RATIO

|       | Description                 | QTY | Application Summary                            | Spicer Part # |
|-------|-----------------------------|-----|--|---------------|
| Front | Ring & Pinion               | 1   | Jeep Wrangler JL with Dana 44™ AdvanTEK® Front | 10046055      |
|       | Performance Diff Cover-Gray | 1   | Jeep Wrangler JL with Dana 44™ AdvanTEK® Front | 10044799*     |
|       | Master Overhaul Kit         | 1   | Jeep Wrangler JL with Dana 44™ AdvanTEK® Front | 10040469      |
| Rear  | Ring & Pinion               | 1   | Jeep Wrangler JL with Dana 44™ AdvanTEK® Rear  | 10062017      |
|       | Performance Diff Cover-Gray | 1   | Jeep Wrangler JL with Dana 44™ AdvanTEK® Rear  | 10040651*     |
|       | Master Overhaul Kit         | 1   | Jeep Wrangler JL with Dana 44™ AdvanTEK® Rear  | 10040478      |

### SPICER® BUNDLE FOR THE JL RUBICON 4.56 RATIO

|       | Description                 | QTY | Application Summary                            | Spicer Part # |
|-------|-----------------------------|-----|--|---------------|
| Front | Ring & Pinion               | 1   | Jeep Wrangler JL with Dana 44™ AdvanTEK® Front | 10050939      |
|       | Performance Diff Cover-Gray | 1   | Jeep Wrangler JL with Dana 44™ AdvanTEK® Front | 10044799*     |
|       | Master Overhaul Kit         | 1   | Jeep Wrangler JL with Dana 44™ AdvanTEK® Front | 10040469      |
| Rear  | Ring & Pinion               | 1   | Jeep Wrangler JL with Dana 44™ AdvanTEK® Rear  | 10067141      |
|       | Performance Diff Cover-Gray | 1   | Jeep Wrangler JL with Dana 44™ AdvanTEK® Rear  | 10040651*     |
|       | Master Overhaul Kit         | 1   | Jeep Wrangler JL with Dana 44™ AdvanTEK® Rear  | 10040478      |

### SPICER® BUNDLE FOR THE JL RUBICON 5.13 RATIO

|       | Description                 | QTY | Application Summary                            | Spicer Part # |
|-------|-----------------------------|-----|--|---------------|
| Front | Ring & Pinion               | 1   | Jeep Wrangler JL with Dana 44™ AdvanTEK® Front | 10051004      |
|       | Performance Diff Cover-Gray | 1   | Jeep Wrangler JL with Dana 44™ AdvanTEK® Front | 10044799*     |
|       | Master Overhaul Kit         | 1   | Jeep Wrangler JL with Dana 44™ AdvanTEK® Front | 10040469      |
| Rear  | Ring & Pinion               | 1   | Jeep Wrangler JL with Dana 44™ AdvanTEK® Rear  | 10067157      |
|       | Performance Diff Cover-Gray | 1   | Jeep Wrangler JL with Dana 44™ AdvanTEK® Rear  | 10040651*     |
|       | Master Overhaul Kit         | 1   | Jeep Wrangler JL with Dana 44™ AdvanTEK® Rear  | 10040478      |

\* Current bundles above include grey diff cover. Blue diff cover option available. See page 24.

### SPICER® BUNDLE FOR THE JL RUBICON 4.10 RATIO

|       | Description                 | QTY | Application Summary                            | Spicer Part # |
|-------|-----------------------------|-----|--|---------------|
| Front | Ring & Pinion               | 1   | Jeep Wrangler JL with Dana 44™ AdvanTEK® Front | 10006435      |
|       | Performance Diff Cover-Gray | 1   | Jeep Wrangler JL with Dana 44™ AdvanTEK® Front | 10044799*     |
|       | Master Overhaul Kit         | 1   | Jeep Wrangler JL with Dana 44™ AdvanTEK® Front | 10040469      |
| Rear  | Ring & Pinion               | 1   | Jeep Wrangler JL with Dana 44™ AdvanTEK® Rear  | 10062033      |
|       | Performance Diff Cover-Gray | 1   | Jeep Wrangler JL with Dana 44™ AdvanTEK® Rear  | 10040651*     |
|       | Master Overhaul Kit         | 1   | Jeep Wrangler JL with Dana 44™ AdvanTEK® Rear  | 10040478      |

### SPICER® BUNDLE FOR THE JL RUBICON 4.88 RATIO

|       | Description                 | QTY | Application Summary                            | Spicer Part # |
|-------|-----------------------------|-----|--|---------------|
| Front | Ring & Pinion               | 1   | Jeep Wrangler JL with Dana 44™ AdvanTEK® Front | 10051746      |
|       | Performance Diff Cover-Gray | 1   | Jeep Wrangler JL with Dana 44™ AdvanTEK® Front | 10044799*     |
|       | Master Overhaul Kit         | 1   | Jeep Wrangler JL with Dana 44™ AdvanTEK® Front | 10040469      |
| Rear  | Ring & Pinion               | 1   | Jeep Wrangler JL with Dana 44™ AdvanTEK® Rear  | 10073110      |
|       | Performance Diff Cover-Gray | 1   | Jeep Wrangler JL with Dana 44™ AdvanTEK® Rear  | 10040651*     |
|       | Master Overhaul Kit         | 1   | Jeep Wrangler JL with Dana 44™ AdvanTEK® Rear  | 10040478      |

### SPICER® BUNDLE FOR THE JL RUBICON 5.38 RATIO

|       | Description                 | QTY | Application Summary                            | Spicer Part # |
|-------|-----------------------------|-----|--|---------------|
| Front | Ring & Pinion               | 1   | Jeep Wrangler JL with Dana 44™ AdvanTEK® Front | 10050979      |
|       | Performance Diff Cover-Gray | 1   | Jeep Wrangler JL with Dana 44™ AdvanTEK® Front | 10044799*     |
|       | Master Overhaul Kit         | 1   | Jeep Wrangler JL with Dana 44™ AdvanTEK® Front | 10040469      |
| Rear  | Ring & Pinion               | 1   | Jeep Wrangler JL with Dana 44™ AdvanTEK® Rear  | 10067204      |
|       | Performance Diff Cover-Gray | 1   | Jeep Wrangler JL with Dana 44™ AdvanTEK® Rear  | 10040651*     |
|       | Master Overhaul Kit         | 1   | Jeep Wrangler JL with Dana 44™ AdvanTEK® Rear  | 10040478      |

## SPICER® and SVL® RING & PINION UPGRADE BUNDLES - 2007-2018 NON-RUBICON JK

### SPICER® BUNDLE FOR THE JK NON-RUBICON 3.73 RATIO

|       | Description                 | QTY | Application Summary                                | Spicer Part # |
|-------|-----------------------------|-----|--|---------------|
| Front | Ring & Pinion               | 1   | Jeep Wrangler JK with Dana 30™ Front (3.73 Ratio)  | 2005021-5     |
|       | Performance Diff Cover-Gray | 1   | Nodular Iron Differential Cover - Dana 30™         | 10023534**    |
|       | Master Overhaul Kit         | 1   | Wrangler JK Non-Rubicon Dana 30™ - Front           | 2017378       |
| Rear  | Ring & Pinion               | 1   | Jeep Wrangler JK with Dana 44™ - Rear (3.73 Ratio) | 2008688       |
|       | Performance Diff Cover-Gray | 1   | Nodular Iron Differential Cover - Dana 44™         | 10023536**    |
|       | Master Overhaul Kit         | 1   | 2008-15 Wrangler JK Non-Rubicon Dana 44™ - Rear    | 2017109*      |

\* 2007 model year required Master Overhaul Kit PN# 2017102

### SPICER® BUNDLE FOR THE JK NON-RUBICON 4.10 RATIO

|       | Description                 | QTY | Application Summary                                | Spicer Part # |
|-------|-----------------------------|-----|--|---------------|
| Front | Ring & Pinion               | 1   | Jeep Wrangler JK with Dana 30™ Front (4.10 Ratio)  | 2005027-5     |
|       | Performance Diff Cover-Gray | 1   | Nodular Iron Differential Cover - Dana 30™         | 10023534**    |
|       | Master Overhaul Kit         | 1   | 2007 Wrangler JK Non-Rubicon Dana 30™ - Front      | 2017378       |
| Rear  | Ring & Pinion               | 1   | Jeep Wrangler JK with Dana 44™ - Rear (4.10 Ratio) | 2008688       |
|       | Performance Diff Cover-Gray | 1   | Nodular Iron Differential Cover - Dana 44™         | 10023536**    |
|       | Master Overhaul Kit         | 1   | 2008-15 Wrangler JK Non-Rubicon Dana 44™ - Rear    | 2017109*      |

\* 2007 model year required Master Overhaul Kit PN# 2017102

### SPICER® BUNDLE FOR THE JK NON-RUBICON 4.56 RATIO

|       | Description                 | QTY | Application Summary                                | Spicer Part # |
|-------|-----------------------------|-----|--|---------------|
| Front | Ring & Pinion               | 1   | Jeep Wrangler JK with Dana 30™ Front (4.56 Ratio)  | 10026645      |
|       | Performance Diff Cover-Gray | 1   | Nodular Iron Differential Cover - Dana 30™         | 10023534**    |
|       | Master Overhaul Kit         | 1   | Wrangler JK Non-Rubicon Dana 30™ - Front           | 2017378       |
| Rear  | Ring & Pinion               | 1   | Jeep Wrangler JK with Dana 44™ - Rear (4.56 Ratio) | 2008688       |
|       | Performance Diff Cover-Gray | 1   | Nodular Iron Differential Cover - Dana 44™         | 10023536**    |
|       | Master Overhaul Kit         | 1   | 2008-15 Wrangler JK Non-Rubicon Dana 44™ - Rear    | 2017109*      |

\* 2007 model year required Master Overhaul Kit PN# 2017102

### SPICER® BUNDLE FOR THE JK NON-RUBICON 4.88 RATIO

|       | Description                 | QTY | Application Summary                                | Spicer Part # |
|-------|-----------------------------|-----|--|---------------|
| Front | Ring & Pinion               | 1   | Jeep Wrangler JK with Dana 30™ Front (4.88 Ratio)  | 10026639      |
|       | Performance Diff Cover-Gray | 1   | Nodular Iron Differential Cover - Dana 30™         | 10023534**    |
|       | Master Overhaul Kit         | 1   | 2007 Wrangler JK Non-Rubicon Dana 30™ - Front      | 2017378       |
| Rear  | Ring & Pinion               | 1   | Jeep Wrangler JK with Dana 44™ - Rear (4.88 Ratio) | 2008688       |
|       | Performance Diff Cover-Gray | 1   | Nodular Iron Differential Cover - Dana 44™         | 10023536**    |
|       | Master Overhaul Kit         | 1   | 2008-15 Wrangler JK Non-Rubicon Dana 44™ - Rear    | 2017109*      |

\* 2007 model year required Master Overhaul Kit PN# 2017102

### SPICER® BUNDLE FOR THE JK NON-RUBICON 5.13 RATIO

|       | Description                 | QTY | Application Summary                                | Spicer Part # |
|-------|-----------------------------|-----|--|---------------|
| Front | Ring & Pinion               | 1   | Jeep Wrangler JK with Dana 30™ Front (5.13 Ratio)  | 10026642      |
|       | Performance Diff Cover-Gray | 1   | Nodular Iron Differential Cover - Dana 30™         | 10023534**    |
|       | Master Overhaul Kit         | 1   | 2007 Wrangler JK Non-Rubicon Dana 30™ - Front      | 2017378       |
| Rear  | Ring & Pinion               | 1   | Jeep Wrangler JK with Dana 44™ - Rear (5.13 Ratio) | 2008688       |
|       | Performance Diff Cover-Gray | 1   | Nodular Iron Differential Cover - Dana 44™         | 10023536**    |
|       | Master Overhaul Kit         | 1   | 2008-15 Wrangler JK Non-Rubicon Dana 44™ - Rear    | 2017109*      |

\* 2007 model year required Master Overhaul Kit PN# 2017102

\*\* Current bundles above include grey diff cover. Blue diff cover option available. See page 24.

### SVL® BUNDLE FOR THE JK NON-RUBICON 3.73 RATIO

|       | Description                 | QTY | Application Summary                                | SVL Part # |
|-------|-----------------------------|-----|--|------------|
| Front | Ring & Pinion               | 1   | Jeep Wrangler JK with Dana 30™ Front (3.73 Ratio)  | NA         |
|       | Performance Diff Cover-Gray | 1   | Nodular Iron Differential Cover - Dana 30™         | 10023534** |
|       | Master Overhaul Kit         | 1   | Wrangler JK Non-Rubicon Dana 30™ - Front           | 2017378    |
| Rear  | Ring & Pinion               | 1   | Jeep Wrangler JK with Dana 44™ - Rear (3.73 Ratio) | NA         |
|       | Performance Diff Cover-Gray | 1   | Nodular Iron Differential Cover - Dana 44™         | 10023536** |
|       | Master Overhaul Kit         | 1   | 2008-15 Wrangler JK Non-Rubicon Dana 44™ - Rear    | 2017109*   |

### SVL® BUNDLE FOR THE JK NON-RUBICON 4.10 RATIO

|       | Description                 | QTY | Application Summary                                | SVL Part # |
|-------|-----------------------------|-----|--|------------|
| Front | Ring & Pinion               | 1   | Jeep Wrangler JK with Dana 30™ Front (4.10 Ratio)  | NA         |
|       | Performance Diff Cover-Gray | 1   | Nodular Iron Differential Cover - Dana 30™         | 10023534** |
|       | Master Overhaul Kit         | 1   | Wrangler JK Non-Rubicon Dana 30™ - Front           | 2017378    |
| Rear  | Ring & Pinion               | 1   | Jeep Wrangler JK with Dana 44™ - Rear (4.10 Ratio) | NA         |
|       | Performance Diff Cover-Gray | 1   | Nodular Iron Differential Cover - Dana 44™         | 10023536** |
|       | Master Overhaul Kit         | 1   | 2008-15 Wrangler JK Non-Rubicon Dana 44™ - Rear    | 2017109*   |

### SVL® BUNDLE FOR THE JK NON-RUBICON 4.56 RATIO

|       | Description                 | QTY | Application Summary                                | SVL Part # |
|-------|-----------------------------|-----|--|------------|
| Front | Ring & Pinion               | 1   | Jeep Wrangler JK with Dana 30™ Front (4.56 Ratio)  | 10010173   |
|       | Performance Diff Cover-Gray | 1   | Nodular Iron Differential Cover - Dana 30™         | 10023534** |
|       | Master Overhaul Kit         | 1   | Wrangler JK Non-Rubicon Dana 30™ - Front           | 2017378    |
| Rear  | Ring & Pinion               | 1   | Jeep Wrangler JK with Dana 44™ - Rear (4.56 Ratio) | 2020746    |
|       | Performance Diff Cover-Gray | 1   | Nodular Iron Differential Cover - Dana 44™         | 10023536** |
|       | Master Overhaul Kit         | 1   | 2008-15 Wrangler JK Non-Rubicon Dana 44™ - Rear    | 2017109*   |

### SVL® BUNDLE FOR THE JK NON-RUBICON 4.88 RATIO

|       | Description                 | QTY | Application Summary                                | SVL Part # |
|-------|-----------------------------|-----|--|------------|
| Front | Ring & Pinion               | 1   | Jeep Wrangler JK with Dana 30™ Front (4.88 Ratio)  | 10010176   |
|       | Performance Diff Cover-Gray | 1   | Nodular Iron Differential Cover - Dana 30™         | 10023534** |
|       | Master Overhaul Kit         | 1   | Wrangler JK Non-Rubicon Dana 30™ - Front           | 2017378    |
| Rear  | Ring & Pinion               | 1   | Jeep Wrangler JK with Dana 44™ - Rear (4.88 Ratio) | 2020749    |
|       | Performance Diff Cover-Gray | 1   | Nodular Iron Differential Cover - Dana 44™         | 10023536** |
|       | Master Overhaul Kit         | 1   | 2008-15 Wrangler JK Non-Rubicon Dana 44™ - Rear    | 2017109*   |

### SVL® BUNDLE FOR THE JK NON-RUBICON 5.13 RATIO

|       | Description                 | QTY | Application Summary                                | SVL Part # |
|-------|-----------------------------|-----|--|------------|
| Front | Ring & Pinion               | 1   | Jeep Wrangler JK with Dana 30™ Front (5.13 Ratio)  | 10010179   |
|       | Performance Diff Cover-Gray | 1   | Nodular Iron Differential Cover - Dana 30™         | 10023534** |
|       | Master Overhaul Kit         | 1   | Wrangler JK Non-Rubicon Dana 30™ - Front           | 2017378    |
| Rear  | Ring & Pinion               | 1   | Jeep Wrangler JK with Dana 44™ - Rear (5.13 Ratio) | 2020752    |
|       | Performance Diff Cover-Gray | 1   | Nodular Iron Differential Cover - Dana 44™         | 10023536** |
|       | Master Overhaul Kit         | 1   | 2008-15 Wrangler JK Non-Rubicon Dana 44™ - Rear    | 2017109*   |

## SPICER® and SVL® RING & PINION UPGRADE BUNDLES-2007-2018 RUBICON JK

Dana has provided its drivetrain expertise to Jeep manufacturing since 1941. We know Jeeps—we know their specifications, and we know the people who have made Jeep synonymous with adventure. As Jeep enthusiasts upgrade their axles to accommodate larger tires, Dana understands the range of parts needed to make that modification successful. That's why we've engineered a range of ring and pinion sets to match these axle ratios.



### SPICER® BUNDLE FOR THE JK RUBICON 3.73 RATIO

|       | Description            | QTY | Application Summary                                | Spicer Part # |
|-------|------------------------|-----|--|---------------|
| Front | Ring & Pinion          | 1   | Jeep Wrangler JK with Dana 44™ Front (3.73 Ratio)  | 2013742-5     |
|       | Performance Diff Cover | 1   | Nodular Iron Differential Cover-Dana 44™ - Gray    | 10023536**    |
|       | Master Overhaul Kit    | 1   | Wrangler JK Rubicon Dana 44™ - Front               | 2017106       |
| Rear  | Ring & Pinion          | 1   | Jeep Wrangler JK with Dana 44™ - Rear (3.73 Ratio) | 2008688       |
|       | Performance Diff Cover | 1   | Nodular Iron Differential Cover-Dana 44™ - Gray    | 10023536**    |
|       | Master Overhaul Kit    | 1   | 2008-2018 Wrangler JK Non-Rubicon Dana 44™ - Rear  | 2010110*      |

\* 2007 model year required Master Overhaul Kit PN# 2017103

### SVL® BUNDLE FOR THE JK RUBICON 3.73 RATIO

|       | Description            | QTY | Application Summary                                | SVL Part # |
|-------|------------------------|-----|--|------------|
| Front | Ring & Pinion          | 1   | Jeep Wrangler JK with Dana 44™ Front (3.73 Ratio)  | NA         |
|       | Performance Diff Cover | 1   | Nodular Iron Differential Cover-Dana 44™ - Gray    | 10023536** |
|       | Master Overhaul Kit    | 1   | Wrangler JK Rubicon Dana 44™ - Front               | 2017106    |
| Rear  | Ring & Pinion          | 1   | Jeep Wrangler JK with Dana 44™ - Rear (3.73 Ratio) | NA         |
|       | Performance Diff Cover | 1   | Nodular Iron Differential Cover-Dana 44™ - Gray    | 10023536** |
|       | Master Overhaul Kit    | 1   | 2008-2018 Wrangler JK Non-Rubicon Dana 44™ - Rear  | 2010110*   |

### SPICER® BUNDLE FOR THE JK RUBICON 4.88 RATIO

|       | Description            | QTY | Application Summary                                | Spicer Part # |
|-------|------------------------|-----|--|---------------|
| Front | Ring & Pinion          | 1   | Jeep Wrangler JK W/Dana 44™ Front (4.88 Ratio)     | 2019749       |
|       | Performance Diff Cover | 1   | Nodular Iron Differential Cover-Dana 44™ - Gray    | 10023536**    |
|       | Master Overhaul Kit    | 1   | Wrangler JK Rubicon Dana 44™ - Front               | 2017106       |
| Rear  | Ring & Pinion          | 1   | Jeep Wrangler JK with Dana 44™ - Rear (4.88 Ratio) | 2018737       |
|       | Performance Diff Cover | 1   | Nodular Iron Differential Cover-Dana 44™ - Gray    | 10023536**    |
|       | Master Overhaul Kit    | 1   | 2008-2018 Wrangler JK Non-Rubicon Dana 44™ - Rear  | 2010110*      |

\* 2007 model year required Master Overhaul Kit PN# 2017103

### SVL® BUNDLE FOR THE JK RUBICON 4.88 RATIO

|       | Description            | QTY | Application Summary                                | SVL Part # |
|-------|------------------------|-----|--|------------|
| Front | Ring & Pinion          | 1   | Jeep Wrangler JK with Dana 44™ Front (4.88 Ratio)  | 10010203   |
|       | Performance Diff Cover | 1   | Nodular Iron Differential Cover-Dana 44™ - Gray    | 10023536** |
|       | Master Overhaul Kit    | 1   | Wrangler JK Rubicon Dana 44™ - Front               | 2017106    |
| Rear  | Ring & Pinion          | 1   | Jeep Wrangler JK with Dana 44™ - Rear (4.88 Ratio) | 2020749    |
|       | Performance Diff Cover | 1   | Nodular Iron Differential Cover-Dana 44™ - Gray    | 10023536** |
|       | Master Overhaul Kit    | 1   | 2008-2018 Wrangler JK Non-Rubicon Dana 44™ - Rear  | 2010110*   |

### SPICER® BUNDLE FOR THE JK RUBICON 4.10 RATIO

|       | Description            | QTY | Application Summary                                | Spicer Part # |
|-------|------------------------|-----|--|---------------|
| Front | Ring & Pinion          | 1   | Jeep Wrangler JK with Dana 44™ Front (3.73 Ratio)  | 2005024-5     |
|       | Performance Diff Cover | 1   | Nodular Iron Differential Cover-Dana 44™ - Gray    | 10023536**    |
|       | Master Overhaul Kit    | 1   | Wrangler JK Rubicon Dana 44™ - Front               | 2017106       |
| Rear  | Ring & Pinion          | 1   | Jeep Wrangler JK with Dana 44™ - Rear (4.10 Ratio) | 2007772       |
|       | Performance Diff Cover | 1   | Nodular Iron Differential Cover-Dana 44™ - Gray    | 10023536**    |
|       | Master Overhaul Kit    | 1   | 2008-2018 Wrangler JK Non-Rubicon Dana 44™ - Rear  | 2010110*      |

\* 2007 model year required Master Overhaul Kit PN# 2017103

### SVL® BUNDLE FOR THE JK RUBICON 4.10 RATIO

|       | Description            | QTY | Application Summary                               | SVL Part # |
|-------|------------------------|-----|---|------------|
| Front | Ring & Pinion          | 1   | Jeep Wrangler JK with Dana 44™ Front (3.73 Ratio) | NA         |
|       | Performance Diff Cover | 1   | Nodular Iron Differential Cover-Dana 44™ - Gray   | 10023536** |
|       | Master Overhaul Kit    | 1   | Wrangler JK Rubicon Dana 44™ - Front              | 2017106    |
| Rear  | Ring & Pinion          | 1   | Jeep Wrangler JK W/Dana 44™ -Rear (4.10 Ratio)    | NA         |
|       | Performance Diff Cover | 1   | Nodular Iron Differential Cover-Dana 44™ - Gray   | 10023536** |
|       | Master Overhaul Kit    | 1   | 2008-2018 Wrangler JK Non-Rubicon Dana 44™ - Rear | 2010110*   |

### SPICER® BUNDLE FOR THE JK RUBICON 5.13 RATIO

|       | Description            | QTY | Application Summary                                | Spicer Part No. |
|-------|------------------------|-----|--|-----------------|
| Front | Ring & Pinion          | 1   | Jeep Wrangler JK with Dana 44™ Front (5.13 Ratio)  | 2019752         |
|       | Performance Diff Cover | 1   | Nodular Iron Differential Cover-Dana 44™ - Gray    | 10023536**      |
|       | Master Overhaul Kit    | 1   | Wrangler JK Rubicon Dana 44™ - Front               | 2017106         |
| Rear  | Ring & Pinion          | 1   | Jeep Wrangler JK with Dana 44™ - Rear (5.13 Ratio) | 2018756         |
|       | Performance Diff Cover | 1   | Nodular Iron Differential Cover-Dana 44™ - Gray    | 10023536**      |
|       | Master Overhaul Kit    | 1   | 2008-2018 Wrangler JK Non-Rubicon Dana 44™ - Rear  | 2010110*        |

\* 2007 model year required Master Overhaul Kit PN# 2017103

### SVL® BUNDLE FOR THE JK RUBICON 5.13 RATIO

|       | Description            | QTY | Application Summary                                | SVL Part No. |
|-------|------------------------|-----|--|--------------|
| Front | Ring & Pinion          | 1   | Jeep Wrangler JK with Dana 44™ Front (5.13 Ratio)  | 10010206     |
|       | Performance Diff Cover | 1   | Nodular Iron Differential Cover-Dana 44™ - Gray    | 10023536**   |
|       | Master Overhaul Kit    | 1   | Wrangler JK Rubicon Dana 44™ - Front               | 2017106      |
| Rear  | Ring & Pinion          | 1   | Jeep Wrangler JK with Dana 44™ - Rear (5.13 Ratio) | 2020752      |
|       | Performance Diff Cover | 1   | Nodular Iron Differential Cover-Dana 44™ - Gray    | 10023536**   |
|       | Master Overhaul Kit    | 1   | 2008-2018 Wrangler JK Non-Rubicon Dana 44™ - Rear  | 2010110*     |

### SPICER® BUNDLE FOR THE JK RUBICON 4.56 RATIO

|       | Description            | QTY | Application Summary                                | Spicer Part # |
|-------|------------------------|-----|--|---------------|
| Front | Ring & Pinion          | 1   | Jeep Wrangler JK with Dana 44™ Front (4.56 Ratio)  | 2019746       |
|       | Performance Diff Cover | 1   | Nodular Iron Differential Cover-Dana 44™ - Gray    | 10023536**    |
|       | Master Overhaul Kit    | 1   | Wrangler JK Rubicon Dana 44™ - Front               | 2017106       |
| Rear  | Ring & Pinion          | 1   | Jeep Wrangler JK with Dana 44™ - Rear (4.56 Ratio) | 2018737       |
|       | Performance Diff Cover | 1   | Nodular Iron Differential Cover-Dana 44™ - Gray    | 10023536**    |
|       | Master Overhaul Kit    | 1   | 2008-2018 Wrangler JK Non-Rubicon Dana 44™ - Rear  | 2010110*      |

\* 2007 model year required Master Overhaul Kit PN# 2017103

\*\* Current bundles above include grey diff cover. Blue diff cover option available. See page 24.

### SVL® BUNDLE FOR THE JK RUBICON 4.56 RATIO

|       | Description            | QTY | Application Summary                                | SVL Part # |
|-------|------------------------|-----|--|------------|
| Front | Ring & Pinion          | 1   | Jeep Wrangler JK with Dana 44™ Front (4.56 Ratio)  | 10010200   |
|       | Performance Diff Cover | 1   | Nodular Iron Differential Cover-Dana 44™ - Gray    | 10023536** |
|       | Master Overhaul Kit    | 1   | Wrangler JK Rubicon Dana 44™ - Front               | 2017106    |
| Rear  | Ring & Pinion          | 1   | Jeep Wrangler JK with Dana 44™ - Rear (4.56 Ratio) | 2020746    |
|       | Performance Diff Cover | 1   | Nodular Iron Differential Cover-Dana 44™ - Gray    | 10023536** |
|       | Master Overhaul Kit    | 1   | 2008-2018 Wrangler JK Non-Rubicon Dana 44™ - Rear  | 2010110*   |

### SPICER® BUNDLE FOR THE JK RUBICON 5.38 RATIO

|       | Description            | QTY | Application Summary                                | Spicer Part No. |
|-------|------------------------|-----|--|-----------------|
| Front | Ring & Pinion          | 1   | Jeep Wrangler JK with Dana 44™ Front (5.38 Ratio)  | 10010738        |
|       | Performance Diff Cover | 1   | Nodular Iron Differential Cover-Dana 44™ - Gray    | 10023536**      |
|       | Master Overhaul Kit    | 1   | Wrangler JK Rubicon Dana 44™ - Front               | 2017106         |
| Rear  | Ring & Pinion          | 1   | Jeep Wrangler JK with Dana 44™ - Rear (5.38 Ratio) | 10027182        |
|       | Performance Diff Cover | 1   | Nodular Iron Differential Cover-Dana 44™ - Gray    | 10023536**      |
|       | Master Overhaul Kit    | 1   | 2008-2018 Wrangler JK Non-Rubicon Dana 44™ - Rear  | 2010110*        |

\* 2007 model year required Master Overhaul Kit PN# 2017103

\*\* Current bundles above include grey diff cover. Blue diff cover option available. See page 24.

### SVL® BUNDLE FOR THE JK RUBICON 5.38 RATIO

|       | Description            | QTY | Application Summary                                | SVL Part No. |
|-------|------------------------|-----|--|--------------|
| Front | Ring & Pinion          | 1   | Jeep Wrangler JK with Dana 44™ Front (5.38 Ratio)  | 10010209     |
|       | Performance Diff Cover | 1   | Nodular Iron Differential Cover-Dana 44™ - Gray    | 10023536**   |
|       | Master Overhaul Kit    | 1   | Wrangler JK Rubicon Dana 44™ - Front               | 2017106      |
| Rear  | Ring & Pinion          | 1   | Jeep Wrangler JK with Dana 44™ - Rear (5.38 Ratio) | 10012316     |
|       | Performance Diff Cover | 1   | Nodular Iron Differential Cover-Dana 44™ - Gray    | 10023536**   |
|       | Master Overhaul Kit    | 1   | 2008-2018 Wrangler JK Non-Rubicon Dana 44™ - Rear  | 2010110*     |



## AXLE UPGRADE PACKAGES - 2007-2018 RUBICON JEEP® WRANGLER JK



Upgrading to an Ultimate Dana 44™ axle on your JK? You'll need to upgrade your rear axle as well. Look for your ratio here, and then discover the additional components you need to finish the job. Once you increase your tire size, you'll need to ensure the correct axle ratio and gear ratio to help you achieve the amount of torque and optimal mileage you're looking for. Check out our calculators at [www.SpicerParts.com/Calculators](http://www.SpicerParts.com/Calculators) today.

### SPICER® BUNDLE FOR THE JK RUBICON 5.38 RATIO

| Description            | Application Summary                                   | Spicer Part # |
|------------------------|---|---------------|
| Drive Axle Assembly    | Ultimate Dana 44™ Axle Assembly (JK 5.38 Ratio) Front | 10010742      |
| Spicer Ring & Pinion   | Jeep Wrangler JK - Rear (5.38 Ratio)                  | 10027182      |
| Performance Diff Cover | Nodular Iron Differential Cover - Dana 44™ - Gray     | 10023536**    |
| Master Overhaul Kit    | 2008-2018 Wrangler JK Non-Rubicon Dana 44™ - Rear     | 2010110*      |

\* 2007 model year required Master Overhaul Kit PN# 2017103

### SPICER® BUNDLE FOR THE JK RUBICON 5.13 RATIO

| Description            | Application Summary                                   | Spicer Part # |
|------------------------|---|---------------|
| Drive Axle Assembly    | Ultimate Dana 44™ Axle Assembly (JK 5.13 Ratio) Front | 10010522      |
| Spicer Ring & Pinion   | Jeep Wrangler JK - Rear (5.13 Ratio)                  | 2018756       |
| Performance Diff Cover | Nodular Iron Differential Cover - Dana 44™ - Gray     | 10023536**    |
| Master Overhaul Kit    | 2008-2018 Wrangler JK Non-Rubicon Dana 44™ - Rear     | 2010110*      |

\* 2007 model year required Master Overhaul Kit PN# 2017103

### SPICER® BUNDLE FOR THE JK RUBICON 4.88 RATIO

| Description            | Application Summary                                   | Spicer Part # |
|------------------------|---|---------------|
| Drive Axle Assembly    | Ultimate Dana 44™ Axle Assembly (JK 4.88 Ratio) Front | 10010521      |
| Spicer Ring & Pinion   | Jeep Wrangler JK - Rear (4.88 Ratio)                  | 2018747       |
| Performance Diff Cover | Nodular Iron Differential Cover - Dana 44™ - Gray     | 10023536**    |
| Master Overhaul Kit    | 2008-2018 Wrangler JK Non-Rubicon Dana 44™ - Rear     | 2010110*      |

\* 2007 model year required Master Overhaul Kit PN# 2017103

\*\* Current bundles above include grey diff cover. Blue diff cover option available. See page 24.

### SPICER® BUNDLE FOR THE JK RUBICON 4.56 RATIO

| Description            | Application Summary                                   | Spicer Part # |
|------------------------|---|---------------|
| Drive Axle Assembly    | Ultimate Dana 44™ Axle Assembly (JK 4.56 Ratio) Front | 10010520      |
| Spicer Ring & Pinion   | Jeep Wrangler JK - Rear (4.56 Ratio)                  | 2018737       |
| Performance Diff Cover | Nodular Iron Differential Cover - Dana 44™ - Gray     | 10023536**    |
| Master Overhaul Kit    | 2008-2018 Wrangler JK Non-Rubicon Dana 44™ - Rear     | 2010110*      |

\* 2007 model year required Master Overhaul Kit PN# 2017103

### SPICER® BUNDLE FOR THE JK RUBICON 4.10 RATIO

| Description            | Application Summary                                   | Spicer Part # |
|------------------------|---|---------------|
| Drive Axle Assembly    | Ultimate Dana 44™ Axle Assembly (JK 4.10 Ratio) Front | 10010455      |
| Spicer Ring & Pinion   | Jeep Wrangler JK - Rear (4.10 Ratio)                  | 2007772       |
| Performance Diff Cover | Nodular Iron Differential Cover - Dana 44™ - Gray     | 10023536**    |
| Master Overhaul Kit    | 2008-2018 Wrangler JK Non-Rubicon Dana 44™ - Rear     | 2010110*      |

\* 2007 model year required Master Overhaul Kit PN# 2017103

### SPICER® BUNDLE FOR THE JK RUBICON 3.73 RATIO

| Description            | Application Summary                                   | Spicer Part # |
|------------------------|---|---------------|
| Drive Axle Assembly    | Ultimate Dana 44™ Axle Assembly (JK 3.73 Ratio) Front | 10010519      |
| Spicer Ring & Pinion   | Jeep Wrangler JK - Rear (3.73 Ratio)                  | 2008688       |
| Performance Diff Cover | Nodular Iron Differential Cover - Dana 44™ - Gray     | 10023536**    |
| Master Overhaul Kit    | 2008-2018 Wrangler JK Non-Rubicon Dana 44™ - Rear     | 2010110*      |

\* 2007 model year required Master Overhaul Kit PN# 2017103



## AXLE UPGRADE PACKAGES - 2007-2018 NON-RUBICON JEEP® WRANGLER JK

### SPICER® BUNDLE FOR THE JK NON-RUBICON 5.38 RATIO

| Description            | Application Summary                                   | Spicer Part # |
|------------------------|---|---------------|
| Drive Axle Assembly    | Ultimate Dana 44™ Axle Assembly (JK 5.38 Ratio) Front | 10010742      |
| Spicer Ring & Pinion   | Jeep Wrangler JK - Rear (5.38 Ratio)                  | 10027182      |
| Performance Diff Cover | Nodular Iron Differential Cover - Dana 44™ - Gray     | 10023536**    |
| Master Overhaul Kit    | 2008-2018 Wrangler JK Non-Rubicon Dana 44™ - Rear     | 2017109*      |

\* 2007 model year required Master Overhaul Kit PN# 2017102

### SPICER® BUNDLE FOR THE JK NON-RUBICON 5.13 RATIO

| Description            | Application Summary                                   | Spicer Part # |
|------------------------|---|---------------|
| Drive Axle Assembly    | Ultimate Dana 44™ Axle Assembly (JK 5.13 Ratio) Front | 10010522      |
| Spicer Ring & Pinion   | Jeep Wrangler JK - Rear (5.13 Ratio)                  | 2018756       |
| Performance Diff Cover | Nodular Iron Differential Cover - Dana 44™ - Gray     | 10023536**    |
| Master Overhaul Kit    | 2008-2018 Wrangler JK Non-Rubicon Dana 44™ - Rear     | 2017109*      |

\* 2007 model year required Master Overhaul Kit PN# 2017102

### SPICER® BUNDLE FOR THE JK NON-RUBICON 4.88 RATIO

| Description            | Application Summary                                   | Spicer Part # |
|------------------------|---|---------------|
| Drive Axle Assembly    | Ultimate Dana 44™ Axle Assembly (JK 4.88 Ratio) Front | 10010521      |
| Spicer Ring & Pinion   | Jeep Wrangler JK - Rear (4.88 Ratio)                  | 2018747       |
| Performance Diff Cover | Nodular Iron Differential Cover - Dana 44™ - Gray     | 10023536**    |
| Master Overhaul Kit    | 2008-2018 Wrangler JK Non-Rubicon Dana 44™ - Rear     | 2017109*      |

\* 2007 model year required Master Overhaul Kit PN# 2017102

\*\* Current bundles above include grey diff cover. Blue diff cover option available. See page 24.

### SPICER® BUNDLE FOR THE JK NON-RUBICON 4.56 RATIO

| Description            | Application Summary                                   | Spicer Part # |
|------------------------|---|---------------|
| Drive Axle Assembly    | Ultimate Dana 44™ Axle Assembly (JK 4.56 Ratio) Front | 10010520      |
| Spicer Ring & Pinion   | Jeep Wrangler JK - Rear (4.56 Ratio)                  | 2018737       |
| Performance Diff Cover | Nodular Iron Differential Cover - Dana 44™ - Gray     | 10023536**    |
| Master Overhaul Kit    | 2008-2018 Wrangler JK Non-Rubicon Dana 44™ - Rear     | 2017109*      |

\* 2007 model year required Master Overhaul Kit PN# 2017102

### SPICER® BUNDLE FOR THE JK NON-RUBICON 4.10 RATIO

| Description            | Application Summary                                   | Spicer Part # |
|------------------------|---|---------------|
| Drive Axle Assembly    | Ultimate Dana 44™ Axle Assembly (JK 4.10 Ratio) Front | 10010455      |
| Spicer Ring & Pinion   | Jeep Wrangler JK - Rear (4.10 Ratio)                  | 2007772       |
| Performance Diff Cover | Nodular Iron Differential Cover - Dana 44™ - Gray     | 10023536**    |
| Master Overhaul Kit    | 2008-2018 Wrangler JK Non-Rubicon Dana 44™ - Rear     | 2017109*      |

\* 2007 model year required Master Overhaul Kit PN# 2017102

### SPICER® BUNDLE FOR THE JK NON-RUBICON 3.73 RATIO

| Description            | Application Summary                                   | Spicer Part # |
|------------------------|---|---------------|
| Drive Axle Assembly    | Ultimate Dana 44™ Axle Assembly (JK 3.73 Ratio) Front | 10010519      |
| Spicer Ring & Pinion   | Jeep Wrangler JK - Rear (3.73 Ratio)                  | 2008688       |
| Performance Diff Cover | Nodular Iron Differential Cover - Dana 44™ - Gray     | 10023536**    |
| Master Overhaul Kit    | 2008-2018 Wrangler JK Non-Rubicon Dana 44™ - Rear     | 2017109*      |

\* 2007 model year required Master Overhaul Kit PN# 2017102

# MAKE MOUNTAINS INTO MOLEHILLS.



## SPICER® FRONT AXLE COMPONENT for DANA 30™ on the JEEP® WRANGLER JL

| Description                          | Spicer Part # |
|--------------------------------------|---------------|
| Friction Modifier/POSI Additive      | 43161         |
| RTV Sealant (2.8 oz.)                | 38615         |
| Inner Pinion Bearing Kit             | 10040443      |
| Collapsible Spacer                   | 10009299      |
| Outer Pinion Bearing Kit             | 10040444      |
| Pinion Bearing Slinger - Outer       | 2005565       |
| Pinion Oil Seal                      | 2014762-1     |
| Pinion Nut                           | 44189         |
| Carrier Cover Bolts                  | 10050881      |
| Differential Bearing Kit             | 10062385      |
| Ring Gear Bolt                       | 41221         |
| Ring Gear Bolt - Pack of 10          | 10040448      |
| Companion Flange Assy.               | 10009253      |
| Transfer Case End Yoke (1310 Series) | 10016266*     |
| Transfer Case End Yoke (1350 Series) | 10016268*     |
| Axle Shaft Nut (JK/JL)               | 2008564       |

\* Replaces OE-Style Companion Flange at Transfer Case

## SPICER® REAR AXLE COMPONENT for DANA 35™ ADVANTEK® on the JEEP® WRANGLER JL

| Description                          | Spicer Part # |
|--------------------------------------|---------------|
| Friction Modifier/POSI Additive      | 43161         |
| RTV Sealant (2.8 oz.)                | 38615         |
| Inner Pinion Bearing Kit             | 10040461      |
| Outer Pinion Bearing Kit             | 2014967-2     |
| Pinion Shim Kit                      | 10040465      |
| Differential Bearing Kit             | 10063464      |
| Differential Shim Kit                | 10040466      |
| Pinion Oil Seal                      | 2010953-2     |
| Axle Shaft Wheel Bearing             | 565904        |
| Axle Shaft Wheel Bearing Retainer    | 10032011      |
| Wheel Seal                           | 2021013-1     |
| Axle Shaft Wheel Stud                | 10047625      |
| Pinion Nut                           | 2009624       |
| Collapsible Spacer                   | 10008365      |
| Companion Flange Assy.               | 10020112      |
| Ring Gear Bolts                      | 10008806      |
| Ring Gear Bolts - 10 pk.             | 10040474      |
| Transfer Case End Yoke (1310 Series) | 10016266*     |
| Transfer Case End Yoke (1350 Series) | 10016268*     |

\* Replaces OE-Style Companion Flange at Transfer Case

## SPICER® FRONT AXLE COMPONENT for DANA 44™ ADVANTEK® on the JEEP® WRANGLER JL

| Description                          | Spicer Part # |
|--------------------------------------|---------------|
| RTV Sealant (2.8 oz.)                | 38615         |
| Friction Modifier/POSI Additive      | 43161         |
| Inner Pinion Bearing Kit             | 10040470      |
| Outer Pinion Bearing Kit             | 10040461      |
| Pinion Shim Kit                      | 10040475      |
| Differential Bearing Kit             | 10067828      |
| Differential Bearing Shim Kit        | 10040476      |
| Collapsible Spacer                   | 10008364      |
| Pinion Nut                           | 2009625       |
| Ring Gear Bolts                      | 10008806      |
| Ring Gear Bolts - 10 pk.             | 10040474      |
| Pinion Oil Seal                      | 10010013      |
| Carrier Cover Bolts                  | 10050881      |
| Carrier Cover Bolts - 12 pk.         | 10062575      |
| Axle Shaft Nut                       | 2008564       |
| Axle Shaft Snap Ring                 | 10025587      |
| Axle Shaft Tube Guide                | 10019730      |
| Axle Shaft Deflector                 | 10062341      |
| FAD Removal Spacer Kit               | 10045078      |
| Companion Flange Assy.               | 10009588      |
| Transfer Case End Yoke (1310 Series) | 10016266*     |
| Transfer Case End Yoke (1350 Series) | 10016268*     |

\* Replaces OE-Style Companion Flange at Transfer Case

## SPICER® REAR AXLE COMPONENT for DANA 44™ ADVANTEK® on the JEEP® WRANGLER JL

| Description                           | Spicer Part # |
|---------------------------------------|---------------|
| RTV Sealant (2.8 oz.)                 | 38615         |
| Friction Modifier/POSI Additive       | 43161         |
| Inner Pinion Bearing Kit              | 10040470      |
| Outer Pinion Bearing Kit              | 2014578-2     |
| Pinion Bearing Shim Kit               | 10040475      |
| Differential Bearing Kit              | 10040472      |
| Differential Bearing Shim Kit         | 10040476      |
| Collapsible Spacer                    | 10008361      |
| Pinion Seal                           | 10039487      |
| Companion Flange                      | 10020110      |
| Pinion Nut                            | 2009625       |
| Transfer Case End Yoke (1310 Series)  | 10016266*     |
| Transfer Case End Yoke (1350 Series)  | 10016268*     |
| Differential Cover Bolts              | 10050881      |
| Ring Gear Bolts                       | 10008806      |
| Ring Gear Bolts - 10 pk.              | 10040474      |
| Wheel Bearing Retainer - Narrow Track | 10032011      |
| Wheel Bearing Retainer - Wide Track   | 10032012      |
| Wheel Bearing Assy.                   | 565903-1      |
| Outboard Axle Shaft Seal              | 10026762      |
| Axle Shaft Bolt                       | 10047625      |

\* Replaces OE-Style Companion Flange at Transfer Case

## SPICER® FRONT AXLE COMPONENTS for DANA 30™ AXLES on the JEEP® WRANGLER JK

| Description                          | Spicer Part # |
|--------------------------------------|---------------|
| Friction Modifier/POSI Additive      | 43161         |
| RTV Sealant (2.8 oz.)                | 38615         |
| Inner Pinion Bearing Kit             | 707064X       |
| Baffle - Pinion Oil                  | 48741-3       |
| Collapsible Spacer                   | 50614         |
| Outer Pinion Bearing Kit             | 706015X       |
| Pinion Bearing Slinger - Outer       | 2005565       |
| Pinion Oil Seal                      | 2004670       |
| Pinion Nut                           | 44189         |
| Carrier Cover Bolts                  | 34279         |
| Differential Bearing Kit             | 706016X       |
| Ring Gear Bolt                       | 41221         |
| Companion Flange Assy. - Front Axle  | 2005008       |
| Transfer Case End Yoke (1310 Series) | 10016266**    |
| Axle Shaft Nut                       | 2008564       |
| Axle Seal - Original Design          | 54381         |
| Axle Seal - Upgraded Design          | 2013455*      |
| Wheel Hub Assembly                   | 10021363      |

\* New design includes integrated axle guide to reduce seal damage during install and three sealing lips compared to one on the original.

\*\* Replaces OE-Style Companion Flange at Transfer Case

## SPICER® REAR AXLE COMPONENTS for DANA 44™ AXLES on the JEEP® WRANGLER JK

| Description                              | Spicer Part # |
|--|---------------|
| RTV Sealant (2.8 oz.)                    | 38615         |
| Friction Modifier/POSI Additive          | 43161         |
| Inner Pinion Bearing Kit                 | 707064X       |
| Outer Pinion Bearing Kit                 | 706123X       |
| Collapsible Spacer                       | 46925         |
| Pinion Thrust Washer                     | 42737         |
| Pinion Seal                              | 2004101       |
| Companion Flange                         | 2004431       |
| Pinion Nut Washer                        | 30275         |
| Pinion Nut                               | 2001153       |
| T-Case Yoke (1310 - 1/2 Round)*          | 10016266      |
| Differential Cover Bolts                 | 34279         |
| Differential Bearing Shim Kit            | 2007294       |
| Ring Gear Bolt-7/16" (15/16" Long)       | 701125-1X     |
| Ring Gear Bolt-7/16" (3/4" Long)         | 701071-10     |
| Carrier Case Cross Shaft (Std/Trac-Lok™) | 703034        |
| Carrier Case Cross Shaft (Std/Trac-Lok™) | 47658         |
| Wheel Bearing Retainer                   | 36797         |
| Wheel Bearing Assy.                      | 565903        |
| Outboard Axle Shaft Seal                 | 52765         |
| Axle Shaft Oil Seal Retainer             | 2004703       |
| Axle Shaft Bolt                          | 2004789       |

\* Replaces OE-Style Companion Flange

## SPICER® FRONT AXLE COMPONENTS for DANA 44™ AXLES on the JEEP® WRANGLER JK

| Description                           | Spicer Part # |
|---------------------------------------|---------------|
| RTV Sealant (2.8 oz.)                 | 38615         |
| Friction Modifier/POSI Additive       | 43161         |
| Inner Pinion Bearing Kit              | 707064X       |
| Baffle - Pinion Oil                   | 48741-3       |
| Collapsible Spacer                    | 50614         |
| Outer Pinion Bearing Kit              | 706015X       |
| Pinion Bearing Slinger - Outer        | 2005565       |
| Pinion Oil Seal                       | 2004670       |
| Pinion Nut                            | 44189         |
| Carrier Cover Bolts                   | 34279         |
| Differential Bearing Kit              | 2007293       |
| Differential Bearing Shim Kit         | 2007294       |
| Companion Flange Assy. - Front Axle   | 2005008       |
| Transfer Case End Yoke (1310 Series)  | 10016266**    |
| Axle Shaft Nut                        | 2008564       |
| Axle Seal - Original Design           | 54381         |
| Axle Seal - Upgraded Design           | 2013455*      |
| Wheel Hub Assembly                    | 10021363      |
| Ball Joint Kit (Upper/Lower Per Side) | 2007354       |
| Upper Ball Joint                      | 2005838       |
| Lower Ball Joint                      | 2011892       |
| Ring Gear Bolt - 10 Pk                | 2007292       |

\* New design includes integrated axle guide to reduce seal damage during install and three sealing lips compared to one on the original.

\*\* Replaces OE-Style Companion Flange at Transfer Case

1941  
Willys MB



Front: Dana 25™  
Rear: Dana 27™

1954  
Jeep CJ



Front: Dana 25™  
Rear: Dana 44™

1987  
Jeep YJ



Front: Dana 30™  
Rear: Dana 35™

Non-Rubicon:  
Front: Dana 30™  
Rear: Dana 44™



1997  
Jeep TJ

Rubicon:  
(starting 2003)  
Front: Dana 44™  
Rear: Dana 44™

2007  
Jeep JK



Non-Rubicon:  
Front: Dana 30™  
Rear: Dana 44™

Rubicon:  
Front: Dana 44™  
Rear: Dana 44™

## Forged in Innovation. A Legendary Relationship 75+ Years Strong.

The “Jeep” vehicle concept was born in answer to the U.S. Army’s call for designs of an easily transportable 4x4 general-purpose vehicle during World War II. Willys-Overland was one of the original manufacturers selected to produce the chosen design, with Dana (then the Spicer Manufacturing Company) providing the driveline components for every vehicle. After the war, Willys-Overland began selling civilian versions of the iconic military vehicle, and Dana’s relationship with the Jeep brand has been going strong ever since. It’s a relationship for the ages—forged in continuous improvement and innovation—that is believed to be the longest continuous supply relationship on the same vehicle in automotive history. And we’re just getting started.

# TODAY

Jeep JL



Base Sport or Sahara Models  
Front: Dana 30™  
Rear: Dana 35™ AdvanTEK®

Rubicon and Select Sport or Sahara Models  
Front: Dana 44™ AdvanTEK®  
Rear: Dana 44™ AdvanTEK®



# #LIVETHESPICERLIFE



**Dana Aftermarket Group**  
PO Box 1000 Maumee, Ohio 43537

Customer Service: 1.800.621.8084  
Email: [DanaNorthAmericaDC@Dana.com](mailto:DanaNorthAmericaDC@Dana.com)

Product information: [SpicerParts.com](http://SpicerParts.com)  
E-catalog and parts locator: [DanaAftermarket.om](http://DanaAftermarket.om)

